



SPEED T



Not responsible for errors. All prices subject to change without notice.
Losi, a Division of Horizon Hobby, Inc.



Table of Contents

Introduction	2
Safety Precautions:.....	3
Supplied and Required Equipment	4
Technical Overview.....	6-8
Battery Overview/Requirements	9
Quick Start	11
Losi MTX Pro Radio System.....	14
Xcelorin Brushless Electronic Speed Control.....	17
Driving the Speed-T.....	21
Tuning, Adjusting and Maintaining the Speed-T	22
Troubleshooting your Speed-T.....	28
Warranty Information	30
RC Terminology.....	32

Introduction

Thank you for purchasing the Losi™ Speed-T RC vehicle including the powerful new Xcelorin™ Brushless System. The Xcelorin brushless system will provide you with the benefit of the latest in brushless technology offering you speed and power with the benefit of low maintenance operation.

We are confident you will be satisfied with the high-speed performance in this durable and resilient vehicle.

Understanding that you are anxiously wanting to get your Speed-T ready for the open road, it will be to your long term benefit to make the effort and read through the entire manual. In the following pages you will find all the information you will need to set up as well as operate your new Speed-T to its full potential.

If you are an experienced RC hobbyist, or new to RC vehicles, it will benefit you to read all enclosed information.

From everyone at Losi we would like to thank you again for choosing the Speed-T. Our goal is helping people have fun and enjoy using our products.

Register your Losi Product Online

Register your Speed-T now and be the first to find out about the latest options parts, product updates and more. Log on to www.LOSI.com and follow the product registration link to stay connected.

Losi/Horizon Support

If you have any questions concerning setup or operation of your Speed-T RC vehicle please call Horizon Customer Support at 1-877-504-0233.

Hours:

Monday thru Friday from 8:00am CST to 5:00pm CST

You are welcome to call us with any support issue, or question you may have about the Speed-T.

Getting Ready

Thoroughly read all the enclosed material, precautions and follow instructions to avoid damaging your new RC vehicle. If you choose to not follow these steps or instructions, it will be considered negligence.

If after review of this manual and prior to running your Speed-T, you determine this RC vehicle is not what you want—DO NOT proceed and DO NOT run the Speed-T. If the Speed-T has been run, your local hobby shop will not be able to process a return or accept it for exchange.



Caution:

THIS PRODUCT IS NOT A TOY. This product is not intended for use by children without direct adult supervision.

This vehicle is capable of extreme speed and careful attention and care must be used when operating the Speed-T.

When driving the Speed-T it is important that you take measures to avoid someone being hit by the vehicle. You may cause serious injury to another person, or to personal property should you make contact while running the Speed-T.

Taking the above Caution into consideration below is a recommendation by experience level of what type of battery and ESC profile are recommended.

Driving Recommendations:

Beginner driver's use:

- Use the Default ESC setting number 3.
- Up to a 6-cell 7.2-volt NiMH battery of 4600mAh or less capacity rating

Novice driver's use:

- Use the Default ESC setting number 3.
- Up to a 6-cell 7.2-volt NiMH battery of 4600mAh or more capacity rating

Intermediate drivers use:

- Use the ESC setting number 2. Changing the profile see page 18.
- Up to a 7-cell 8.4-volt NiMH battery of 4600mAh or less capacity rating
- Up to a 3-cell 11.1-volt LiPo battery of 3500mAh or less capacity rating

Expert drivers use:

- Use the ESC setting number 1. Changing the profile see page 18.
- Any NiMH cell up to 7-cell 8.4-volt side-by-side battery pack
- Up to a 3-cell 11.1-volt LiPo battery of 8000mAh

Safety Precautions:

We hope you operate this RC model in a safe, reasonable and cautious fashion so it leads to your enjoyment and fun with this vehicle. Should you operate this vehicle without a cautious and reasonable approach it may result in serious injury and/or property damage. Only you can control and make certain that safety precautions and instructions are followed.

General:

- The Speed-T is not a toy. This product is not intended for use by children without direct adult supervision.
- This RC Vehicle is not intended for use on public highways or roads.
- Avoid an area that has many pedestrians or crowds of people.
- Keep in mind that this vehicle is radio controlled and can experience moments of radio loss or interference, so provide for a margin of error at all times.
- Please be aware that the motor and batteries of this RC vehicle will get HOT during each use. Be careful not to burn yourself.
- It is not recommended to run this RC Model at dusk and into the evening or if you will lose sight at any point while running the vehicle.

Electronic Speed Control (ESC):

- Read all safety precautions prior to each use.
- Never leave the vehicle/ESC unsupervised while it is switched on, in use or connected to a power source. If there is a short or product defect, it could result in fire.
- If there are exposed wires, do not use the ESC until you have installed shrink-wrap or replaced the wire.
- Disconnect the battery from the ESC after use.
- The ESC is not water proof and should not be exposed to moisture.
- Do not attempt to use more than 3-cell LiPo or seven cells NiMH; doing so will damage the ESC and could result in fire.
- Always turn on the transmitter first then the ESC to prevent an out-of-control vehicle.
- This is a High Performance Brushless System
 - Please disconnect motor or remove the pinion gear during ESC setup or calibration functions.
 - Keep loose clothing, hair, gloves and fingers away from moving parts at all times.
 - Rubber tires can cause severe injury if there is a failure while running the vehicle while on a stand or when being held. Ensure rubber tires are securely mounted to the rims and if not, re-glue them and check them often for security.

Batteries and Charging:

The Speed-T uses rechargeable batteries such as NiMH or LiPo. These batteries all have special requirements to preserve performance and last a long time. Read all instructions and precautions that are provided with the batteries intended to be used in the Speed-T.

- Read all instructions provided by the manufacturer of the batteries.
- Responsible adult supervision is necessary while charging batteries.
- Always check to ensure the polarity of battery connection is correct.
- Never leave batteries unattended while charging.
- Never charge a battery while it is installed in the Speed-T.
- Do not charge any battery that appears to have any damage.
- If there are exposed wires do not charge or use the battery until you have installed shrink-wrap or replaced the complete wire.

If charging NiMH batteries, select a charger to meet your requirements. Chargers can be of two primary types for their source of power; a 100-240V wall charger, or one which requires a 12V power supply. Follow the charger manufacturer's instructions and precautions during each use.

Special Consideration for Using LiPo Batteries and Charging:

Lithium Polymer batteries have gained in popularity for use in RC vehicles because of their size and power capabilities. These batteries must be used with special care and handling. LiPo batteries are only recommended for the experienced hobbyist with knowledge of handling LiPo batteries who completely understands the associated risk when using these batteries. LiPo batteries are extremely sensitive to both over-charging and over-discharging.

The Speed-T can be used with 2- or 3-cell LiPo batteries ONLY.

- 2-cell is 7.4V and fully charged at approximately 8.4V
- 3-cell is 11.1V and fully charged at approximately 12.6V

The supplied Xcelorin Electronic Speed Control (ESC) can support up to and including a 3-cell LiPo only. The ESC has a Low Voltage protection feature that the user must set to match the battery being used. The ESC will turn on the Red LED and reduce power to the motor when the battery voltage has dropped below the cutoff voltage. For LiPo batteries this is typically 3V per cell, ex: a 3-cell LiPo would have a 9.0V voltage cutoff. It is the user's responsibility to ensure that the LiPo battery is not over-discharged.

It is mandatory that if you choose to use a LiPo battery that you (the user) read all instructions and safety precautions supplied by the battery manufacturer. This applies to the selected LiPo charger as well.

Supplied and Required Equipment

Supplied tools:



- 2-Way wrench
- Radio Adjusting Screw Driver
- Transmitter / Receiver BIND Plug
- Four (4) Hex Wrench "L" shaped
.050", 1/16", 5/64", and 3/32"
- Flat Turnbuckle Wrench

Recommended Accessories:

- Hobby grade knife
- CA glue (LOSA7880 or LOSA7881)
- Needle nose pliers
- Side cutting pliers
- Double sided tape (LOSA4004)
- Safety Goggles
- Soldering iron

Required Equipment:

- ① Four (4) AA alkaline batteries for the transmitter.

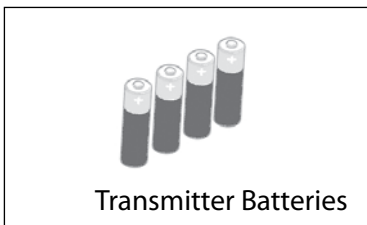

Transmitter Batteries

- ② A Six (6) or Seven (7) cell NiMH battery pack. Or with proper knowledge, LiPo battery packs.

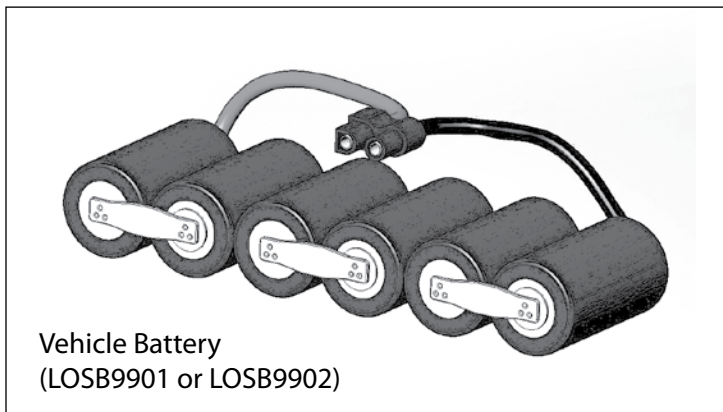

Vehicle Battery
(LOSB9901 or LOSB9902)

- ③ NiMH battery charger with automatic "peak detection" recommended. Or a Lithium Polymer (LiPo) charger that will charge a LiPo battery.



Charger

Using your charger:

If you do not yet have a charger a peak-detecting charger will provide the performance required and take care of your expensive batteries.

A popular choice for a charger would be a peak detection charger that can be plugged into a household A/C wall socket. The peak detection portion of the charger monitors the battery charging and will automatically shut off upon full charge.

The other choice of peak detection charger requires a 12V power source to charge your batteries. You would need to use or purchase a hobby grade 12V power supply before charging.

If you are going to be using a charger other than a peak detection charger it is important to have your battery fully discharged prior to recharging. Many of these have a 15-20 minute timer that allows you to set to the amount of charge time. If the battery was not fully discharged from prior use, you can potentially over charge your battery pack.

Do not charge any battery unattended, and monitor for heat build up. If the battery pack is more than warm to the touch immediately discontinue charging.

Read all safety precautions supplied by the charger manufacture, and also any from the battery manufacture.

Should you use Lithium Polymer batteries (LiPo) you can ONLY use a charger specifically made for charging LiPo batteries.

For more information regarding LiPo batteries please refer to page 9.

Below are items which are not included and can be purchased from your Local Hobby Shop if required.

- ④ Charge adaptor (not included) if the selected charger has a Molex connector, sometimes referred to as a Tamiya Style.

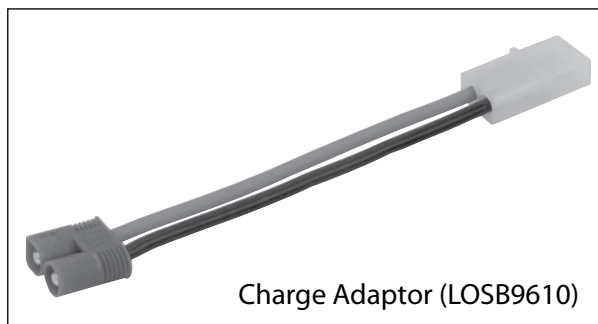

Charge Adaptor (LOSB9610)

OR

The following lead adaptor if the selected charger uses banana plugs.

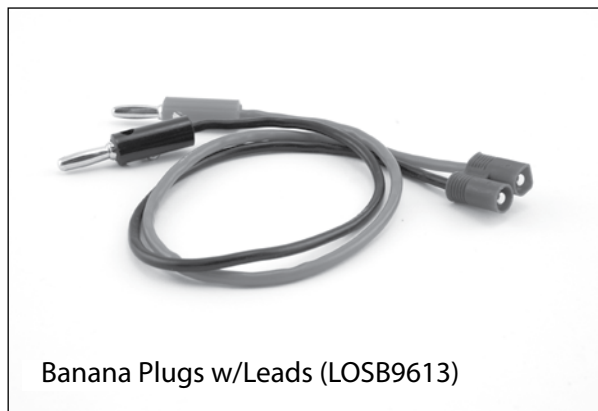

Banana Plugs w/Leads (LOSB9613)

The Losi Speed-T Overview

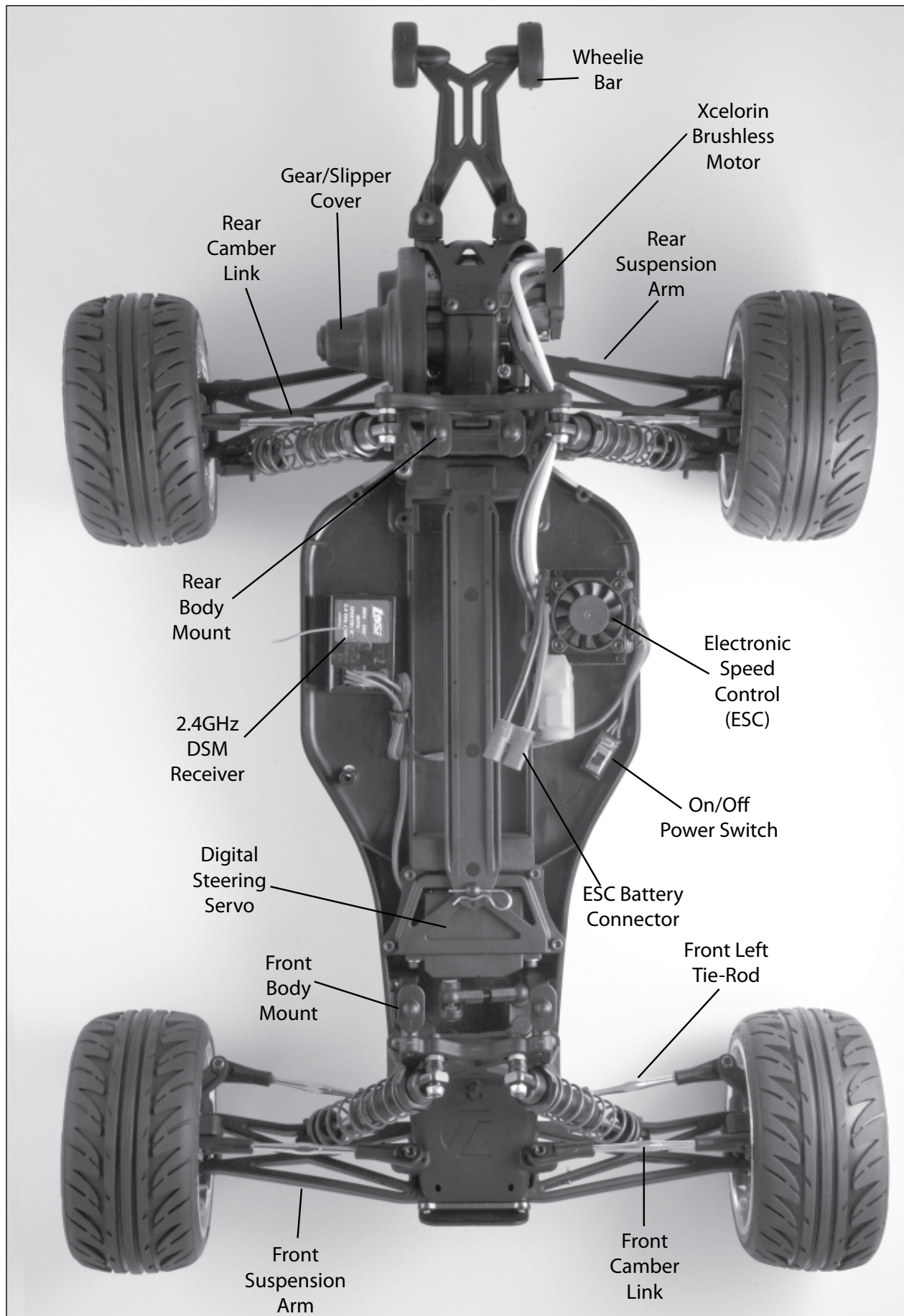

The Losi MTX Pro Radio System Overview

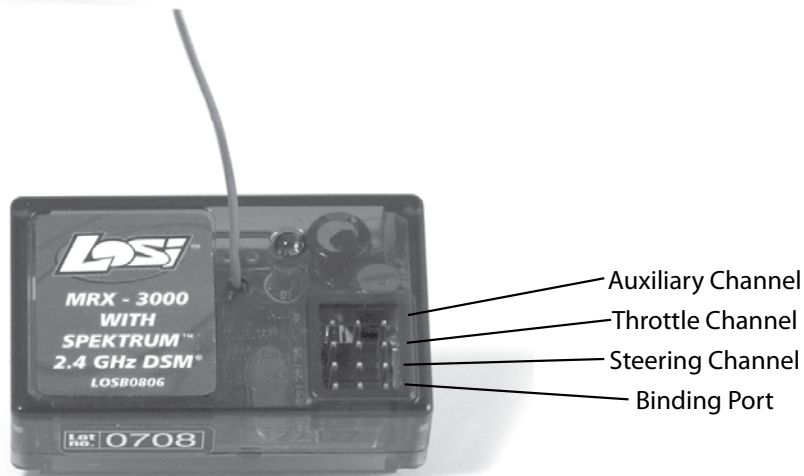
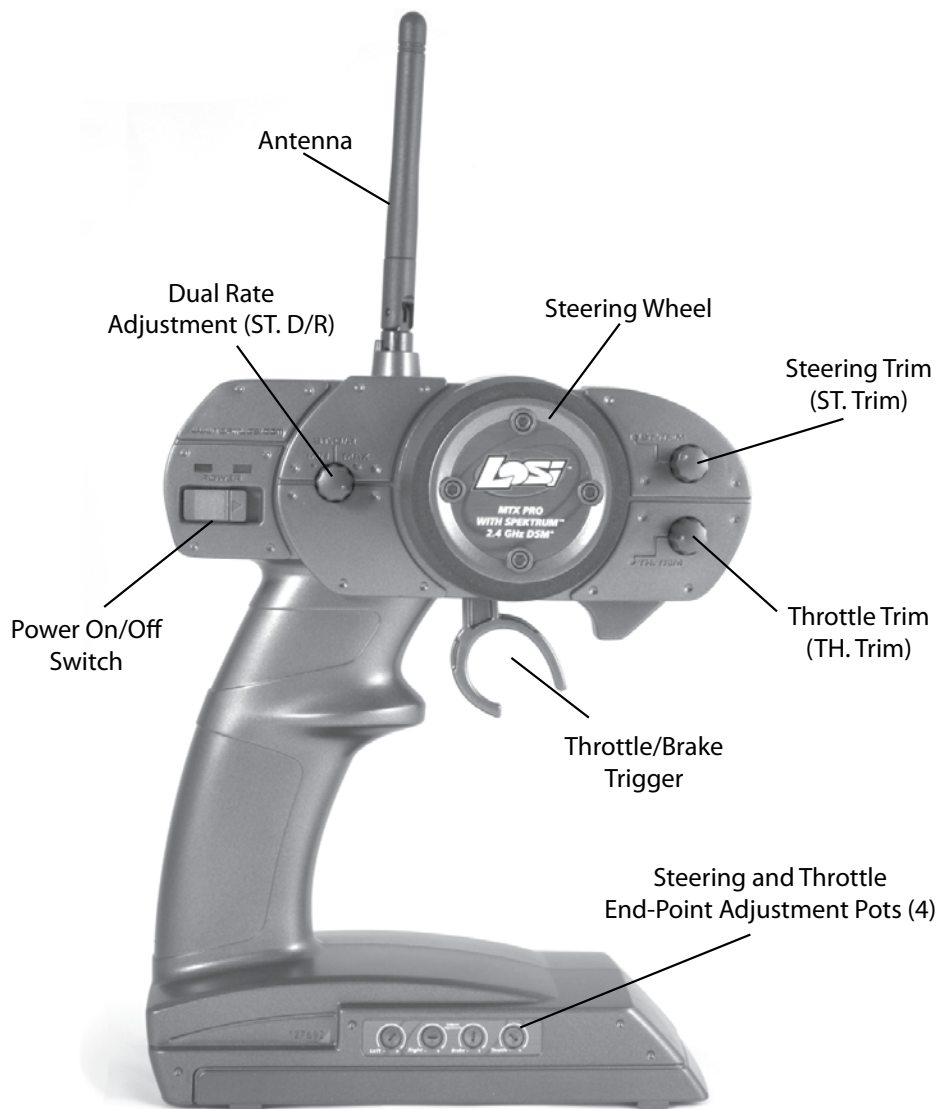

Speed-T Electronics System Overview

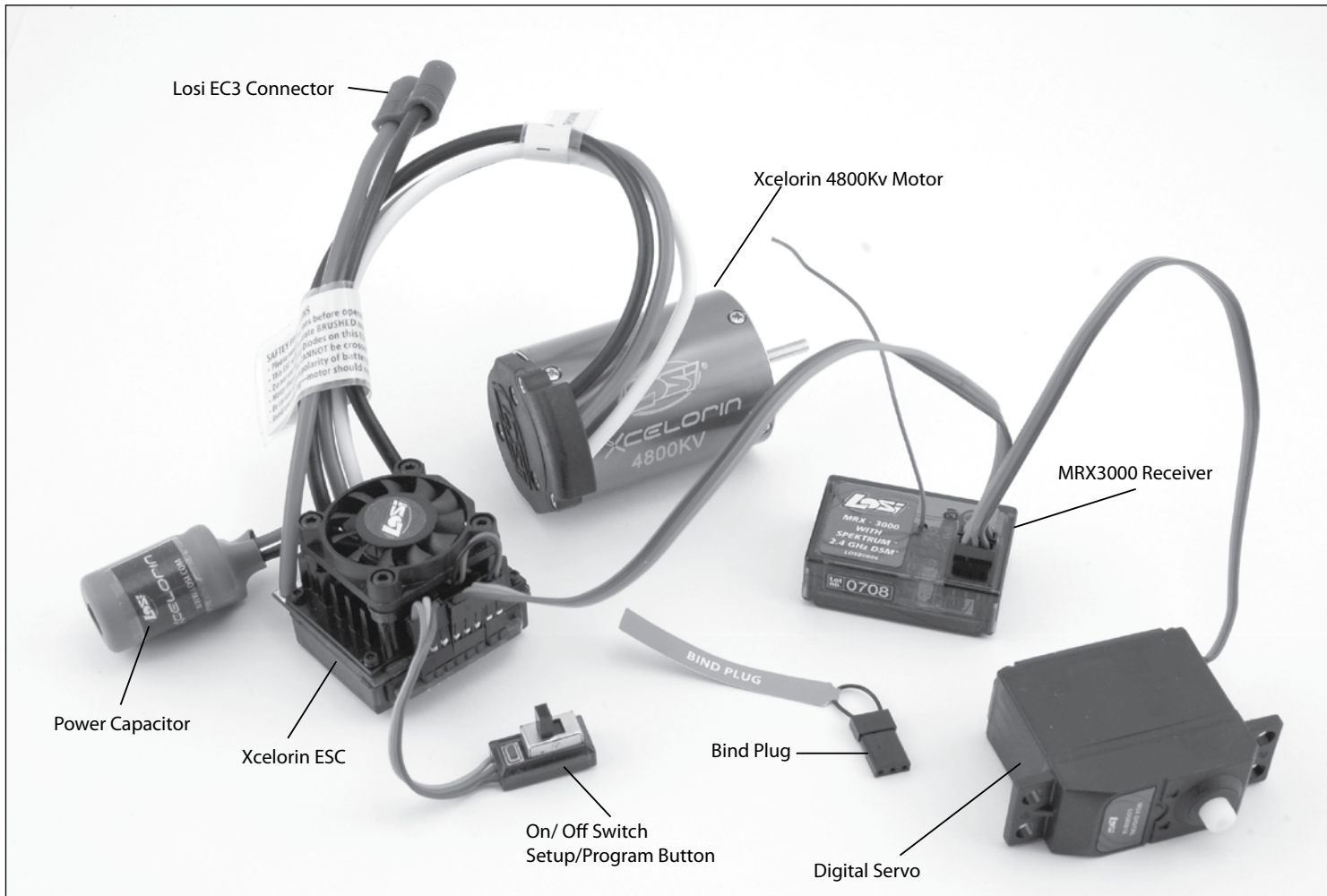

Battery Overview/Requirements

The Speed-T is equipped with the Xcelorin Brushless System combined with the Losi EC3 connector. It has been designed to provide the maximum current flow to the Xcelorin Brushless System.

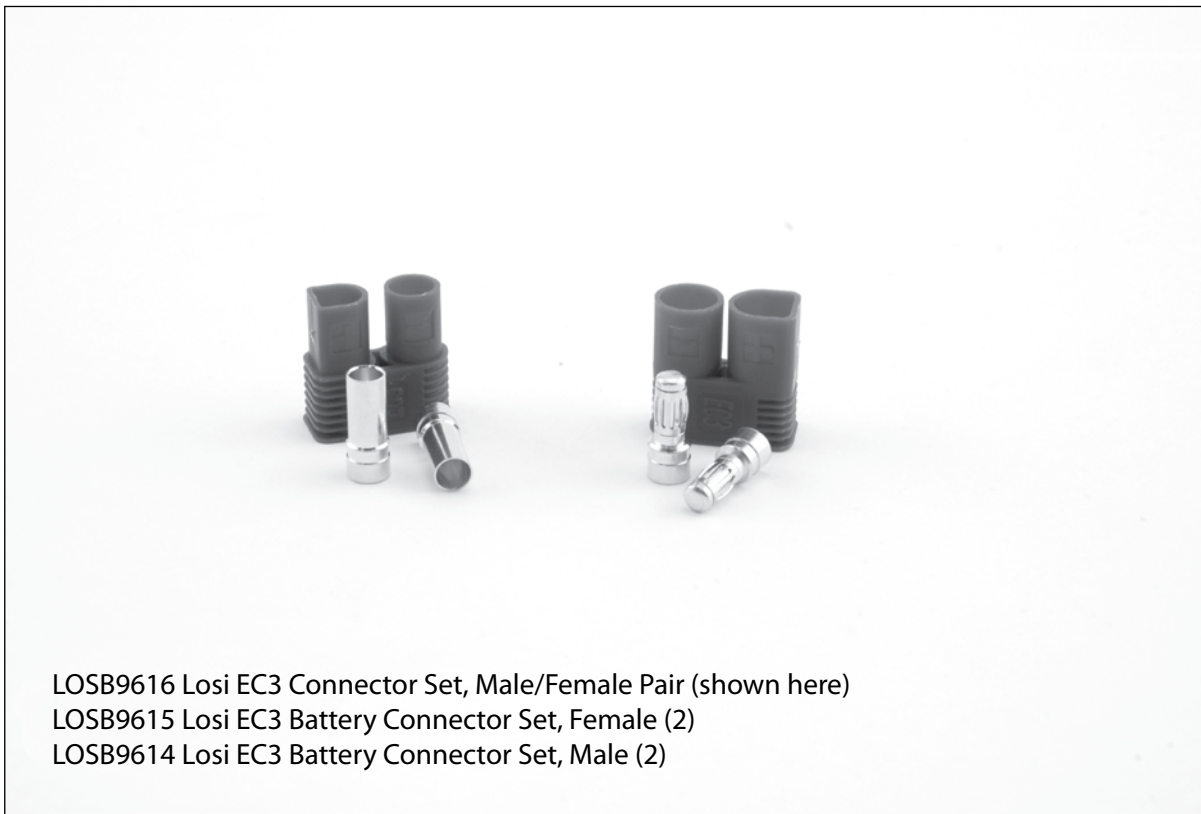

LOSB9616 Losi EC3 Connector Set, Male/Female Pair (shown here)

LOSB9615 Losi EC3 Battery Connector Set, Female (2)

LOSB9614 Losi EC3 Battery Connector Set, Male (2)

It is recommended that you use the Losi EC3 connectors on all your battery packs to ensure efficient power delivery to the Xcelorin Brushless System. The connector is gold plated and is able to handle the high current loads of the Speed-T.

Overview of Battery Packs for Use

All of the Losi recommended batteries, 6-cell or 7-cell side-by-side, and both 2-cell and 3-cell LiPo battery packs come equipped with the Losi EC3 connector.

Only use NiMH or LiPo type batteries. The selected NiMH batteries should be capable of high discharge rates with low internal resistance and should be assembled properly to maintain a high rate of current flow. There are many options to choose from but an investment in a quality battery pack will benefit you, the user, in the enjoyment of your new Speed-T. The less expensive batteries will generally lose their performance after continuous use in this high drain application.

We do not recommend the use of batteries referred to as Stick Packs, they are commonly constructed with thin metal battery connectors and may result in personal injury or fire.

Things to look for in a good quality battery pack are:

- Battery connections
 - High current connector in between the cells, not a thin metal tab.
- Wire leads from the battery.
 - Wire should be 12 or 13 gauge providing high current flow.
- Connector used to connect to the Speed-T.
 - Many battery packs will come with high resistance connectors that will restrict the current flow resulting in poor performance.
 - It is recommended that these be changed to Losi EC3 connectors.

Also ensure there are no exposed wires that may lead to shorting of the positive and negative power leads. A short can cause severe heat and result in personal injury and damage to the battery pack, radio equipment and the Xcelorin ESC. Use good heat-shrink tubing as required to ensure there are no exposed areas that may result in a short.

Losi ONLY recommends the following battery packs be used in the Speed-T.

Below are four (4) types of configurations that will fit nicely in your Speed-T.

6-cell side-by-side configuration

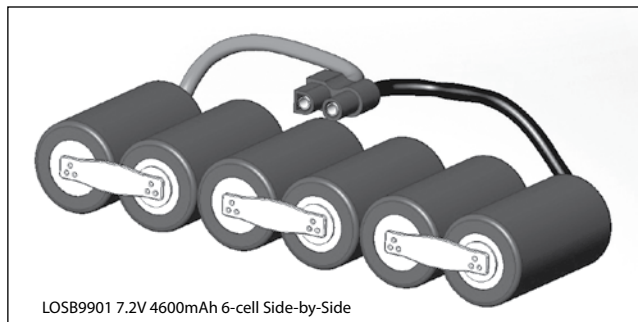

LOS9901 7.2V 4600mAh 6-cell Side-by-Side

7-cell side-by-side configuration

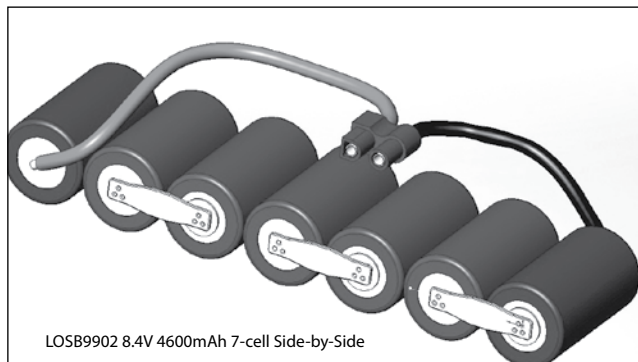

LOS9902 8.4V 4600mAh 7-cell Side-by-Side

2-cell LiPo (experienced experts only)



LOS9861 7.4V 5000mAh 2S LiPo

3-cell LiPo (experienced experts only)



LOS9860 11.1V 3200mAh 3S LiPo

Related accessories (not included) that maybe helpful in the operation of your Speed-T.



LOS9616 Losi EC3 Connector Set, Male/Female Pair (shown here)
 LOS9615 Losi EC3 Battery Connector Set, Female (2)
 LOS9614 Losi EC3 Battery Connector Set, Male (2)

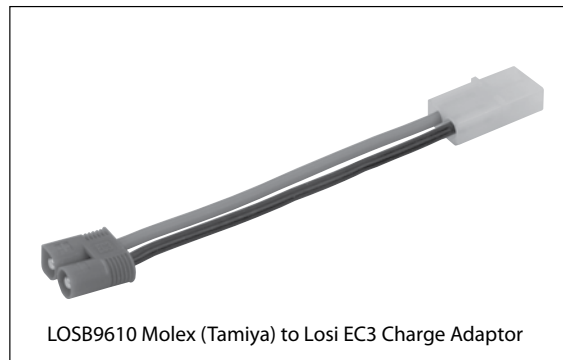

LOS9610 Molex (Tamiya) to Losi EC3 Charge Adaptor



LOS9613 Losi EC3 Charge Adaptor with Banana Plugs
 (Required with Losi LiPo Charger LOS9605)

Installing Batteries:

Transmitter

Remove the battery cover from the bottom of the transmitter by sliding it away from the base of the handle. Install the four (4) AA size batteries (not included) into the base, noting polarity when inserting each battery.

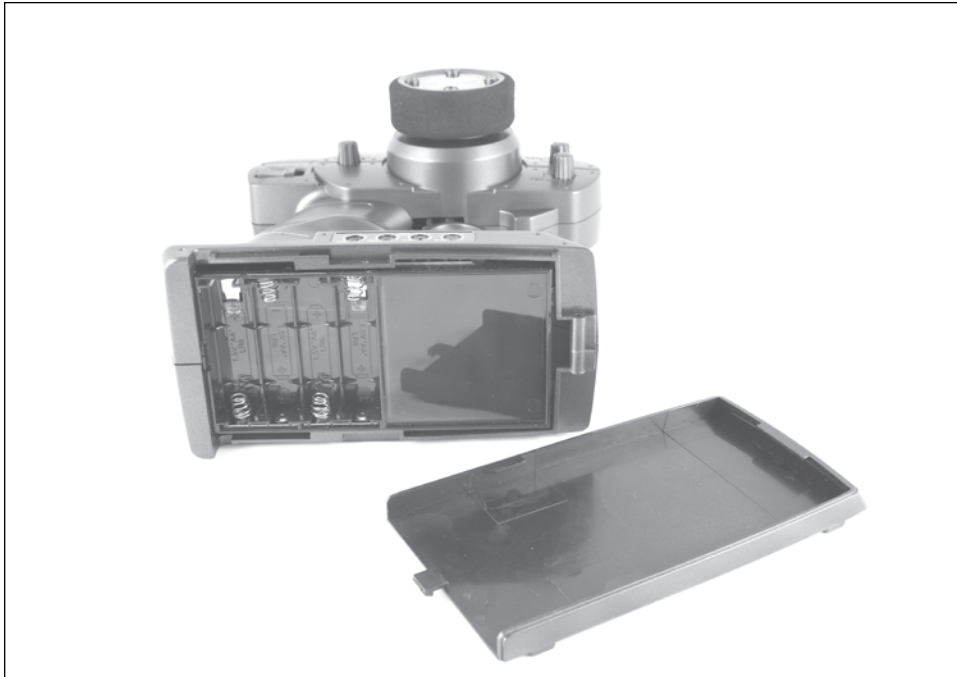

Transmitter with Batteries



Reinstall the battery cover by sliding it back on the handle base.

Battery Pack(s)

To install the battery pack remove the battery hold-down strap by removing the clip from the front mounting boss, and then, while lifting the strap, pulling forward in one motion.

Note: *When using a 7-cell battery pack you must remove one of the foam battery spacers for the battery pack to fit properly into the compartment.*

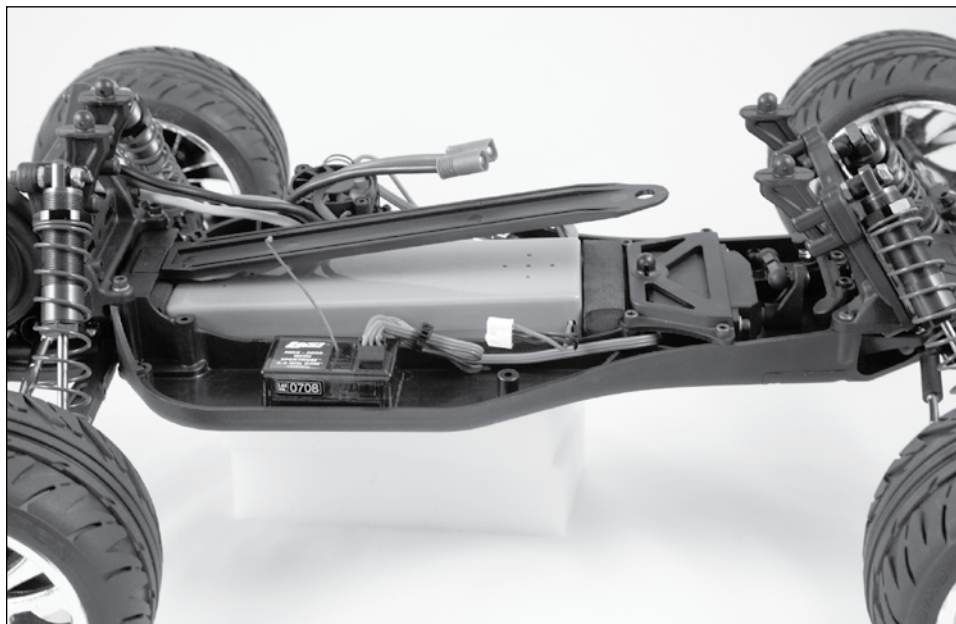

After you have inserted the fully-charged battery pack reinstall the battery hold-down strap.

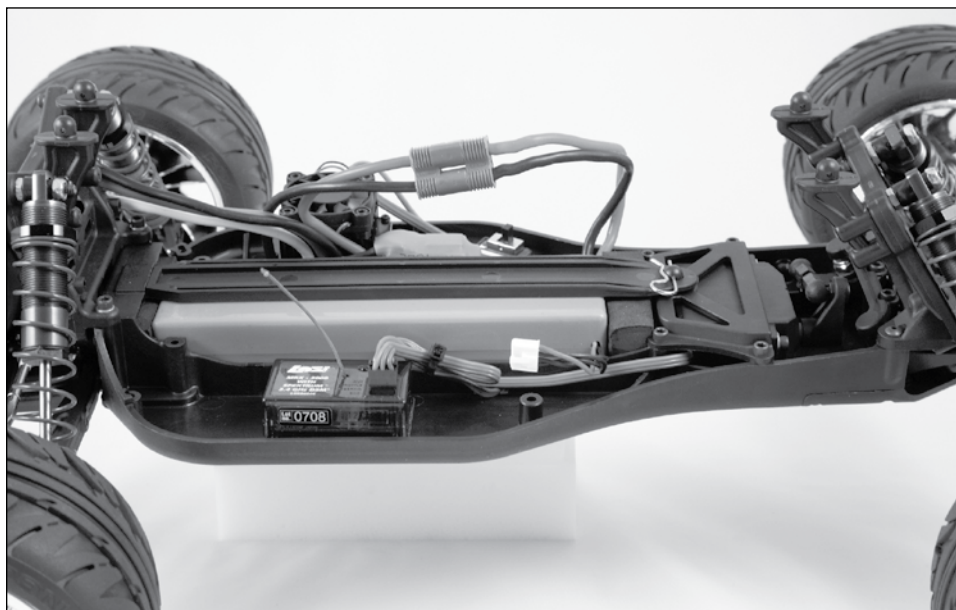

Notice that the battery hold-down has a flat side while the other side has strengthening ribs; the flat side should be facing down to the battery.

Insert on an angle into the rear support, and then down on the front pin and secure it with the previously removed clip.



Quick Start

Note: Please read the entire manual to gain a full understanding of the Speed-T vehicle, your Xcelorin brushless system, fine-tuning the setup and performing maintenance.

- 1. Read the safety precautions found on page 3. This is important for your safety and prevention of personal injury.
- 2. Charge the battery pack you have chosen (NOT INCLUDED). Refer Manufacturer's Supplied instructions for battery charging information.
- 3. Install the AA batteries into the MTX Pro Transmitter (see page 11). Use alkaline or rechargeable batteries only (NOT INCLUDED).
- 4. Install the battery pack (see previous page). This battery pack should be fully charged before installation.
- 5. Turn on the transmitter and then the vehicle. It is a good practice to turn on the transmitter before the vehicle and turn it off after the vehicle has been turned off.
- 6. Please Note! Default profile of the ESC does not provide FULL THROTTLE. Please refer to page 18 for information on profiles.
- 7. Check Steering (see page 14). Verify that the servo is functioning properly.
- 8. Driving the Speed-T (see page 21).
- 9. Performing maintenance of the Speed-T. Refer to Tuning, Adjusting, and Maintenance of the Speed-T on page 22.

Losi MTX Pro Radio System

The Losi MTX Pro DSM[®] radio system included with the Speed-T operates on 2.4GHz and provides 79 unique channels, which are automatically selected when the transmitter and vehicle are turned on. The communication between the transmitter and receiver begins in the few seconds after both are turned on.

They are bound together from the factory to uniquely operate together.

The Losi MTX Pro DSM radio system will not interfere with radio systems operating on legacy frequencies such as 27MHz or 75MHz, neither will you experience any overlapping interference from other 2.4GHZ systems.

Operation and adjustment



Transmitter

The Losi Pro transmitter has several adjustments available to increase your enjoyment of the Speed-T vehicle.

1. **Power switch** – Turns the transmitter On and Off.
2. **Dual rate** – (ST.D/R) Adjusts how much the wheels can turn left/right in equal proportion.
3. **Steering Trim** – (ST.TRIM) Adjusts the “Hands Off” direction of the Speed-T.
4. **Throttle Trim** – (TH.TRIM) Fine adjustment for the throttle and brake center.
5. **End Point Adjustment Pots** – Adjusts the amount of servo movement for steering and throttle/brake (which should be set at 4:00 for proper ESC function).

From Left to Right they adjust the following:

- Right Steering
- Left Steering
- Throttle
- Brake

Using the End Point

Adjustments: All the adjust pots increase throw if turned clockwise and decrease throw turned counter-clockwise.

Steering: First set the steering trim so the Speed-T goes straight without touching the steering wheel. Lift the vehicle off the ground and turn the steering wheel to the right. Using the enclosed mini screw driver to adjust the pot marked "right" back and forth stopping when the wheels can turn to the right no further.

Repeat this process for the pot marked "left."

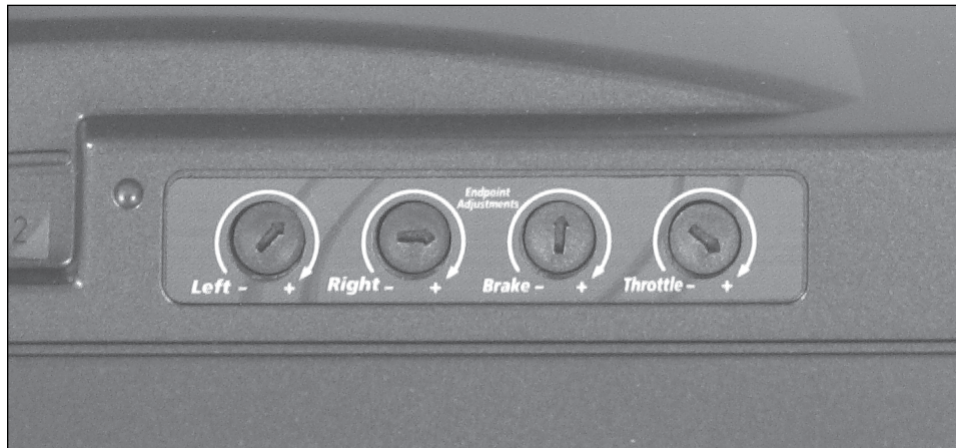

Note: If you feel the vehicle turning more in one direction than the other you can use these pots to reduce the movement of the side turning more.

The Throttle and Brake pots should be set just short of the full movement of each pot. Turn each to full and then back off slightly. If you should be required to adjust throttle and brake endpoints, it is required to reset (calibrate) the transmitter and ESC. (See Page 18 for more details.)

Receiver

There is no adjustment required of the receiver. Please note the different slots for connection.

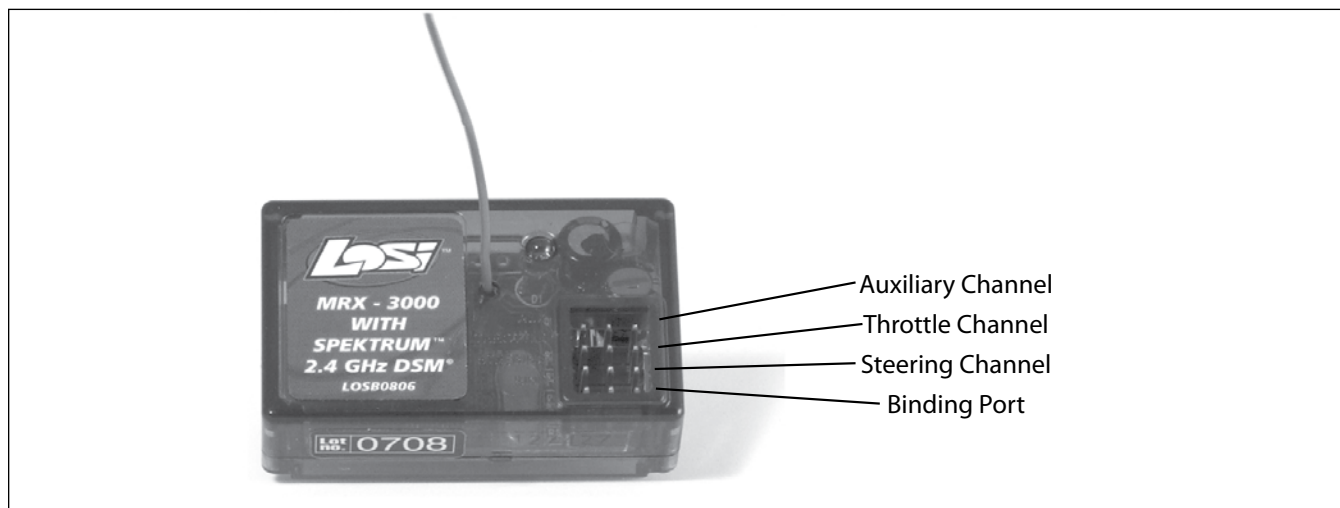

There is Bind, channel one, channel two and auxiliary slots.

The bind slot is used to bind the transmitter to the receiver. The Losi MTX Pro DSM® radio system uses a unique GUID ID to "bind" the transmitter to each receiver. This bind process has been performed during assembly and is described should you replace the receiver or during a trouble shooting exercise you be requested to rebind your transmitter and receiver.

Although the transmitter and receiver are set "bound" at the factory, below are the steps required to re-bind your transmitter and receiver should the need arise.



Re-Bind Process

1. Ensure that the transmitter and vehicle are both turned off.
2. Using the supplied Bind plug (which looks like a standard receiver plug with a short wire loop installed), insert the Bind plug into the receiver slot labeled "BIND." When you look down on the receiver slots it is the slot furthest from the LED, and nearest to the corner of the receiver.

Note: You do not need to remove any other plugs to rebind.

3. With the bind plug installed, turn on the vehicle. Notice the LED is now blinking.
4. You are now ready to turn on the transmitter. You should notice on the back of the transmitter a similar blinking LED under a translucent cover.
5. Both the receiver and transmitter LEDs will stop blinking and be on solid, indicating that they have "Bound" themselves together.
6. Turn off the vehicle and then the transmitter.
7. Remove the "bind" plug from the receiver.
8. Turn on the transmitter and then the vehicle to ensure operation. If the transmitter does not control the vehicle, please repeat steps 1-7 above. If after several attempts you are unsuccessful please call Horizon product support.
9. The bind process is complete. Your vehicle's radio system is now ready for use.

Receiver Antenna

Using your fingers gently straighten the antenna wire to be close to vertical from the chassis for the best radio reception.

Factory Settings of Radio/ESC

The Electronic Speed Control was calibrated together with the Radio System at the Factory. When you turn on and run the Speed-T for the first time you may be required to slightly adjust the Throttle Trim. If the vehicle creeps in reverse or in forward just make a fine adjust to the Throttle trim knob on the transmitter. Sometimes during the bumps and bounces of transportation the settings can be slightly altered.

Xcelorin Brushless Electronic Speed Control

Overview

The Losi Xcelorin electronic speed control (ESC) is specifically designed for operating Sensorless brushless motors. Featuring low on-resistance, enhanced throttle response and strong brakes, this ESC has enough features to satisfy the most demanding driver. The pre-installed high airflow fan attached to the ESC heat sinks keep it cool and performing to the peak of its ability. In order maintain 100A continuous current draw, the Xcelorin ESC uses very high quality electronics and the best MOSFET transistors available.

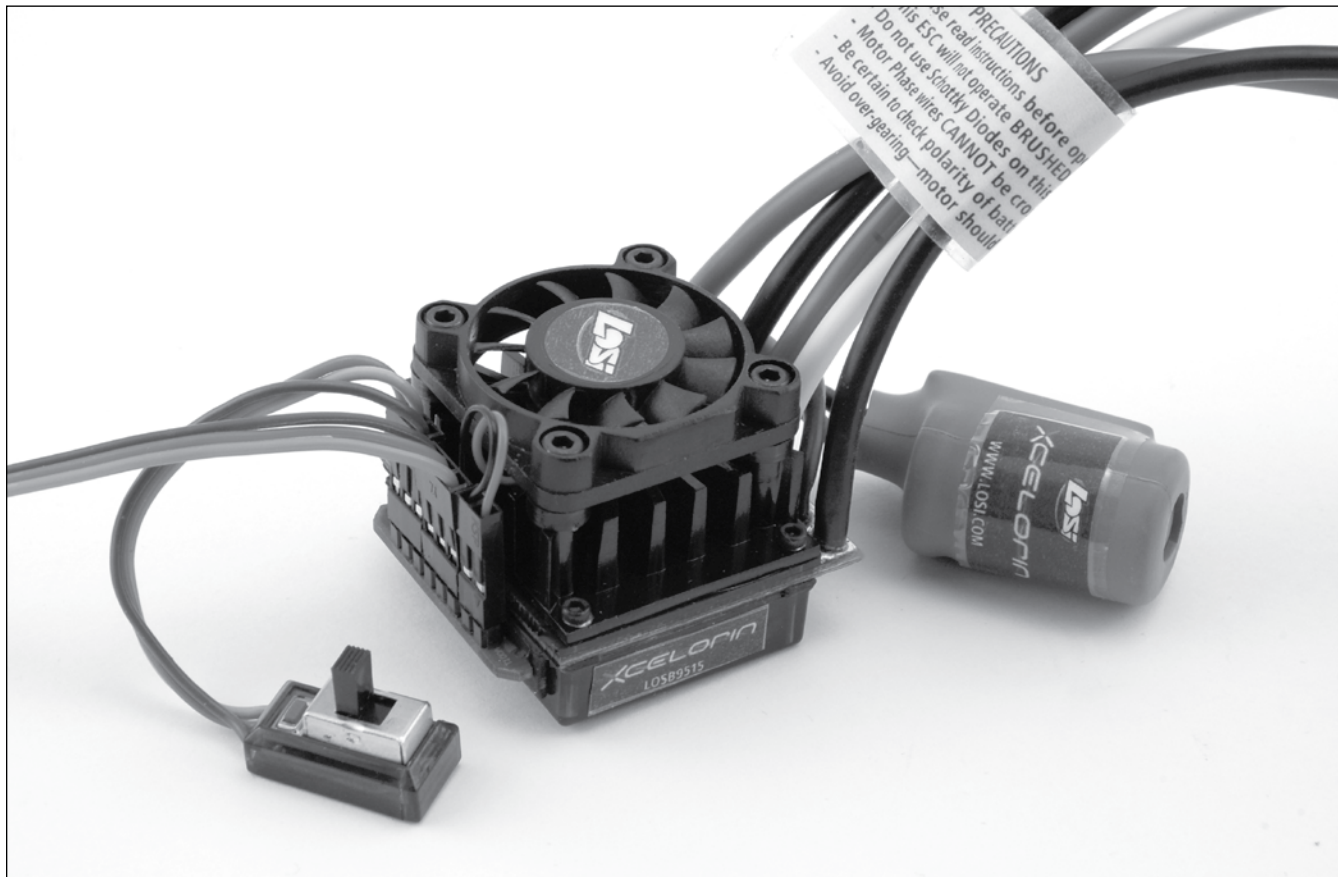

A key feature is the three (3) stored settings within the ESC that are easily recalled for convenient use. These stored settings are referred to as "profiles." These do not limit the functions of the ESC as you can easily use the included Quick Programming Card (QPC) to make changes to any desired setting.

The Low-Voltage-Cutoff (LVC) is pre-set for either NiCd or NiMH batteries. For more experienced users, it can be changed to support both 2-cell and 3-cell LiPo batteries. Using the Quick Programming Card (QPC), adjustments to the ESC can be made quickly and simply.

The Xcelorin ESC has a feature within it to prevent the Speed-T from going into reverse before you have come to a complete stop. Once you have come to a stop, release the throttle trigger to the neutral position. Once you have been at neutral, push the trigger forward to engage reverse (if active). The ESC is also programmed to prevent going directly from reverse drive to forward. The ESC will have a short pause when changing from reverse to going forward to prevent damage to the motor or drivetrain of your vehicle.



Profile Overview

Profile #1 - "High Speed Performance"

Cutoff Voltage-	LiPo 3S
Brake/Reverse Role-	Forward only **
Motor Timing-	Normal
Initial Acceleration-	High **
Drag Brake-	Low
Brake-	Braking
Vehicle Speed-	Maximum
Reverse Speed-	(Not active)

Profile #2 - "Bashing Fun"

Cutoff Voltage-	No Cutoff (NiMH)
Brake/Reverse Role-	Forward with Pause then Reverse **
Motor Timing-	Normal
Initial Acceleration-	Medium **
Drag Brake-	Medium
Brake-	Medium
Vehicle Speed-	Medium
Reverse Speed-	Medium

Profile #3 settings (Default): "Low Speed - Beginner"

Cutoff Voltage-	No Cutoff (NiMH)
Brake/Reverse Role-	Forward with pause then Reverse **
Motor Timing-	Low
Initial Acceleration-	Low **
Drag Brake-	High
Brake-	High
Vehicle Speed-	Low
Reverse Speed-	Medium

** QPC cannot change

Selecting profiles:

Notice that Profile #3 is set from the factory as the DEFAULT.

Overriding the Active Profile

There are three (3) saved profiles within the ESC, previously described.

To override a setting within the active profile, select a saved profile that resembles your needs, or make further changes to the current profile. Review the QPC and set jumpers to your choice. You must make a choice for each area of the QPC, Cutoff Voltage, Brake, Drag Brake, Vehicle Speed, Reverse Speed, and Motor Timing.

For example if you have the ESC active profile set to Profile #3 (Default) and would like a little more speed but change nothing else, place the jumpers on the following choices.

Cut-off Voltage	NiMH
Brake	High
Drag Brake	High
Vehicle Speed	Medium (was Low)
Reverse Speed	Medium
Motor Timing	Low

Then follow the instructions for using the Quick Programming Card. You can change one setting at a time or any combination.

Making the above change is ONLY overriding the active profile. At any time, you can reset the ESC to profile #3 and the active profile is returned to the original profile #3 settings.

Selecting Profiles

1. Turn the Transmitter on.
2. Turn the vehicle on.
3. With the ESC turned on and ready for operation, press & hold the setup button until both the Yellow and Blue LED flash.
4. Release setup button.
5. The status LEDs flash to indicate the current profile setting.

LED status for each Profile below:

Profile 1	Yellow and Blue LED flash
Profile 2	Yellow, Blue and Green LED flash
Profile 3	Yellow, Blue, Green and Red Flash (default setting)

6. To make a change, quickly press the setup button, which will advance you to the next profile.

7. When you are finished, press and hold the setup button 2 seconds, the 4 status LEDs will scroll and the new selection will be stored to the active memory of the ESC.
8. If you do not press the setup button within 15 seconds, the 4 status LEDs will scroll to indicate you are exiting programming. The ESC will return to neutral and be ready for use without any change.

These stored settings, also referred to as "profiles," are defined here.

Modifying ACTIVE profile with the Quick Programming Card (QPC)

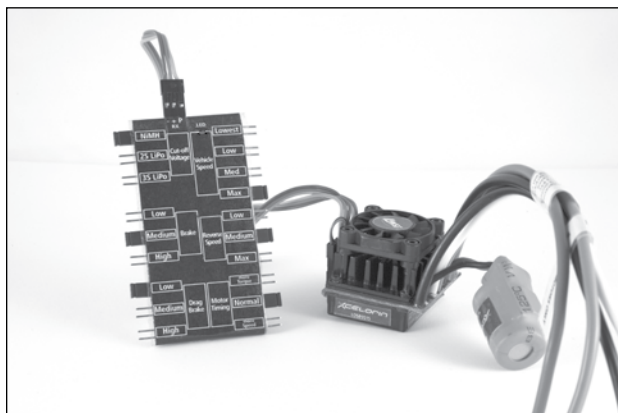

The Xcelorin Quick Programming Card (QPC) is used to make all adjustments to the active profile in your ESC. Any ACTIVE profile can be modified.

Using the QPC you can set the following:

Cut-Off Voltage

- NiMH (NiCd)
- 2S LiPo
- 3S LiPo

Braking Strength

- Low
- Medium
- High

Drag Brake

- Low
- Medium
- High

Vehicle Speed (By throttle limiting)

- Lowest
- Low
- Medium
- Maximum

Reverse Speed

- Low
- Medium
- Maximum

Using the Quick Programming Card

With the QPC in your hand and the back facing you, notice the small jumper connectors. The jumpers are used to indicate which function you want to activate.

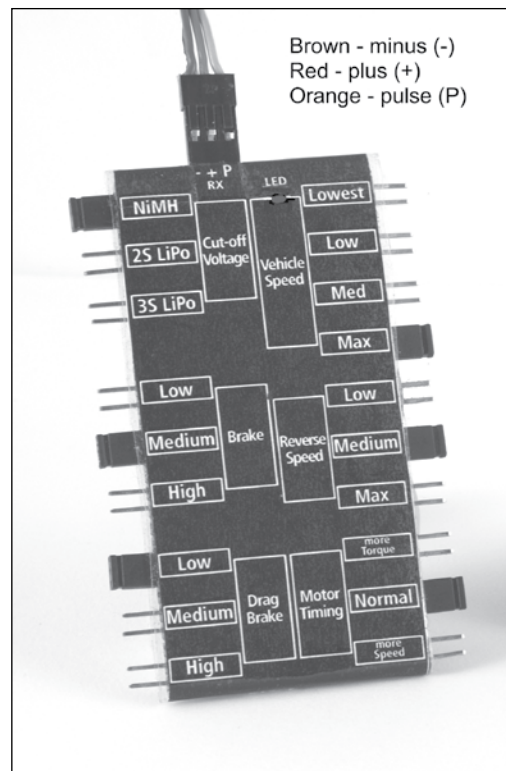

To change the settings rearrange the small jumpers to the desired settings.

To Upload to the ESC do the following:

1. Ensure the transmitter and vehicle are turned off.
2. Make sure a battery pack is installed that has some charge in it.
3. Connect the battery to the vehicle.
4. Turn the power on to the ESC, wait for the Blue (or Blue/Yellow) LED to come on.
5. Disconnect the Signal wire for the ESC from the receiver.
6. Connect the Signal wire to the top of the QPC, ensure it is connected correctly.
7. Pay close attention to the ESC LEDs and you will notice the Red LED flash, and on the QPC the Red LED will come on. If you did not notice the ESC Red LED flash, you can unplug the Signal wire from the QPC and reconnect again to verify the operation of the Red LEDs. Once you see the ESC Red flash and the QPC turn on Red, the ESC accepted the programming.
8. Disconnect the Signal wire from the QPC, turn off the power switch.
9. Reconnect the signal wire into the receiver.
10. The ESC has been updated and you are ready.

Note: If you should happen to lose any of your jumpers they are the same jumpers used with computers and easily obtained at a computer store.

ESC Warning LEDs:

- If the Battery low voltage cutoff (LVC) is reached the Red LED will blink.
- The Red LED will automatically turn off should the battery voltage recover above the Low Voltage Cutoff chosen.
- If the ESC has detected a thermal overload the Yellow LED will blink. Let the ESC to cool down.

Setup / Calibration to Transmitter

To perform the setup/calibration between the ESC and Transmitter follow these steps:

1. Turn on the transmitter.
2. While turning on the vehicle Press and Hold the setup button, notice the Yellow LED is now ON solid. When the Yellow LED is on solid you can release the setup button.

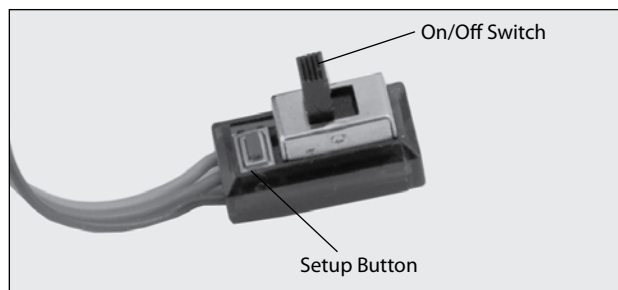

3. Using the throttle trigger pull Full Throttle until the Green LED is ON solid.
4. Next push the throttle trigger to Full Brake until the Red LED is ON solid.
5. Now return the throttle trigger to the Neutral position and the Blue LED is ON solid.
6. Turn off the vehicle/ESC power switch.
7. Turn the vehicle/ESC back ON; you are now ready to use the ESC.

Normal Operation:

- After turning on the vehicle, the Blue LED will be on for normal operation.
- If reverse is active then you will notice the Yellow LED is also on.

Confirmation of Full Throttle and Brake:

- While the ESC is on and operational if you pull the throttle trigger to Full Throttle the Green LED will turn ON Solid.
- Push the throttle trigger to Full Brake, the red LED will turn ON solid.

Note: If the brake endpoint adjustment is reduced after calibration then the Red LED will not turn on.

ESC – reverse operation

Should you get into a situation that requires reverse, after you have applied any brakes you may have needed, return the throttle trigger to the neutral position. Wait a moment or two and then push the trigger forward for reverse.

Note: There is automatic protection within the Xcelorin ESC. Only after you have stopped and returned the trigger to neutral will reverse become available. If you are in reverse you will notice a delay if while travelling in reverse you pull the trigger to go forward. This is to help prevent serious damage to the drivetrain.

Driving the Speed-T

Please note the following precautions before running your Speed-T.

- The Electronics in this vehicle are not waterproof and you must avoid running the vehicle in or through standing water, wet grass, mud or snow.
- This vehicle is very fast:
 - Do not run the vehicle at dusk or in the dark of night.
 - Do not run the vehicle if it will be out of sight for any amount of time.
 - Do not drive your vehicle near a crowd of people.
- Perform a check of the vehicle before going out to run it.
 - Ensure the tires are not coming off the rims.
 - Generally check the vehicle for items such as a loose wheel nut, or anything loose on the steering assembly. The vibrations of running at high speeds tend to loosen screws and nuts.
- The Speed-T's gearing choice from the factory IS NOT meant for running the vehicle Off-Road and especially not in grass.
- Be careful driving when the battery is nearly discharged or the car is running slowly. You could lose enough power for the receiver to shutdown and you may lose control.
- When driving the Speed-T be cautious and use common sense. The speed of this RC vehicle may surprise bystanders who could be injured if you accidentally hit them.
- If your vehicle gets caught or stuck do not pull the throttle in either forward or reverse. This will overload the ESC and/or motor resulting in damage to one or possibly both and is not covered by your warranty.
- After running a battery pack, allow the electronics several minutes to cool, before running the next battery pack.
- When you are running and the batteries are low on charge the ESC reduces the power to the motor. When this happens the batteries are very discharged and continued running may possibly damage your battery. If you are using LiPo batteries when power to the motor is reduced immediately stop running the vehicle. Over discharging of LiPo batteries can be dangerous.

Run time consideration for the Speed-T vehicle.

The single largest factor in run time is the capacity mAh of your battery pack. The larger the mAh rating the more run time you will experience.

For example: if you have a 4600mAh battery pack you can expect close to twice the run time of a 2000mAh battery pack.

The condition of a battery pack is also an important factor in both run time and speed. As batteries see more use they will degrade in performance and capacity.

How you drive your Speed-T will also affect your run times. If you are performing runs, going from a standstill to full speed repeatedly, you are asking a lot from your batteries. Hard acceleration draws a lot of current from any battery and will lead to shortened run time.

Note: Higher mAh rated battery packs will provide power longer during heavy acceleration and long full throttle runs.

If the bearings are dirty they will cause significant drag causing reduced run times and speed.

To improve run times consider the following:

- Keep your vehicle clean and maintained.
- Allow more airflow to the heat sink of the Xcelorin ESC.
- Change the gearing to a lower ratio, this will make the electronics run cooler. This can be accomplished by using a smaller pinion gear, or a larger spur gear than those originally supplied. (The Speed-T comes with a 20-tooth pinion and an 88-tooth spur gear.)
- Change to battery packs of higher mAh rating.
- Is the charger your using the best at charging your batteries? Check with your local hobby dealer.



Tuning, Adjusting and Maintaining the Speed-T

Periodically examine your Speed-T for the following:

- Keep your vehicle clean using a brush to remove dirt and dust.
- Look for cracks in the suspension arms and other molded parts.
- Check that the tires are still glued to the wheels.
- Check that all the wheel bearings are clean and lubricated.
- Using your tools, attempt to tighten all the screws and nuts.
- Verify that the Chamber Links and Steering linkage are not bent.
- Check that the Toe and Chamber settings are as desired and equal.
- Remove the gear cover.
 - Check the Spur gear for wear.
 - Check the Pinion gear.
 - Check the Slipper Pads for wear.
- Take the shocks off the vehicle and check, especially if they appear to be leaking as it is time to rebuild them.
- Look over all the wiring and connections for bare wire or any place which could lead to a short circuit.
- Verify that the ESC and capacitor are securely mounted to the chassis.
- Verify the receiver is still securely mounted to the chassis.
- Turn on the radio and if the Green LED is off or dim replace the 4 AA batteries in the transmitter.

After you become familiar with driving your Speed-T, you may need to reset or make adjustments for better driving performance.

Just as in a real car, alignment is an important factor in your vehicle's handling. When you are ready to make adjustments it is a good idea to have a flat work space to place your vehicle on. This will enable you to easily and more quickly make both Toe-in and Chamber adjustments. These adjustments should be set with the vehicle sitting at its normal ride height.

Tuning the Front End of the Speed-T

Shock Location: The Speed-T has two mounting locations on the front shock tower. The position can be easily adjusted by simply moving the top of the shock to another hole. The standard location (outside hole on the tower) works best on most surfaces. Moving the top of the shock inward a hole will slow steering response and make the Speed-T smoother in bumps. The standard position on the arm is outside, which offers the best balance. Running the inside shock location will give the Speed-T more steering into the turn and less steering on corner exit. Running the shock location outside on the front arm will give you less overall steering into the turn and keep the front end flatter through the turn, making the Speed-T smoother and easier to drive. This can be used on high traction surfaces. Keep in mind as you move the shocks in on the arm this will require internal limiters to obtain the correct suspension travel. For the inside location a total of .200" limiter works great. Losi sells a shock spacer set (LOSA5050) that includes .030", .060", .090" and .120" spacers.

All of the Camber and Steering Linkages have been assembled in the following way.

Using the supplied flat metal turn buckle wrench if you need to SHORTEN any link on the Speed-T rotate the wrench towards the front of the vehicle (counter-clockwise). If you need to LENGTHEN any link then rotate the wrench towards the rear of the vehicle (clockwise).

Static Camber: This refers to the angle of the wheels/tires relative to the surface (viewed from either the front or back). Negative camber means that the top of the tire leans in toward the chassis. Positive camber means the top of the tire leans out, away from the chassis. Camber can be precisely measured with after-market camber gauges, sold at a local hobby shop. It can be measured (roughly) using any square (to the ground) object by checking the gap between the square edge and the top of the tire. Testing has shown that 1 degree of negative camber is best for most track conditions. Increasing negative camber (in the range of 1-2 degrees) will generally increase steering. Decreasing negative camber (in the range of 0-1 degree) will generally decrease steering and the Speed-T will feel easier to drive as a result. This is, most often, a very critical adjustment in tuning your Speed-T that can be made quickly and easily.



Inboard Camber Location: The Speed-T has three different inner locations with vertical adjustment for the front camber tie rod. In general, the lower or further out the inside position is, relative to the outside, the more camber gain (total camber change through the total throw of the suspension) is present. This is an adjustment that is difficult to make a generic statement for as it can have slightly different results on various conditions. The following is a summary of how this adjustment will usually impact the handling of the Speed-T. A longer front camber link will usually make the Speed-T feel stiffer. This will help keep the Speed-T flatter with less roll, but can make the Speed-T handle worse in bumpy conditions, it also will make the Speed-T easier to drive. A shorter front camber link will result in more front end roll, which will provide more steering on tighter turns with the loss of some stability. You will also lose some high speed steering but might gain some more steering response. Too short of a front link may make the Speed-T feel "twitchy" or "wandery" meaning that it may be difficult to drive straight at high speed.

Inboard Camber Vertical Adjustment: Washers are often used under the inner ball stud mounting location; this is one of the most important adjustments on the Speed-T. You should get a feel for how the number of washers affects the handling. Adding washers will make the Speed-T more stable and keep the front end flatter. This works well on higher traction surfaces. Removing washers will make the steering more aggressive, which works well on lower traction surfaces. This can be good in some conditions, but can also make the Speed-T difficult to drive in others. The best all-around adjustment is with three washers as the vehicle comes built. The washers that are used are included in an assortment package of washers (LOSA6350).

Outboard Camber Location: In addition to the inboard camber location, the Speed-T also provides outboard three mounting options. The middle location is the most used as it provides the best and most consistent handling on different surfaces. The outer location also helps the Speed-T stay tighter in turns with a more precise steering feel. Moving the link to the inner hole will make the steering react slightly slower and steer smoother. The advantage to the inner hole is that it can increase on power steering and help the Speed-T get through bumps better.

Toe-In/Out: This is the parallel relationship of the front tires to one another. Toe-in/out adjustments are made by changing the overall length of the steering tie rods. Toe-in (the front of the tires point inward, to a point in front of the front axle) will make the Speed-T react a little slower, but have more steering from the middle of the turn, out. The opposite is true with toe-out (the front of the tires point outward, coming to a point behind the front axle), the Speed-T will turn into the corner better but with a decrease in steering from the middle of the turn, out. Toe-in will help the Speed-T to "track" better on long straight high speed runs, where toe-out has a tendency to make the Speed-T wander. We recommend to run between 0-degree of toe-in/out to 1 degree of toe-in.

Bump-In/Out: Bump-out (front of the front tires toe-outward under suspension compression) will result in more off-power steering and less consistent handling if you have too much bump-out. This effect is obtained by adding washers under the steering spindle ball stud. Bump-in (front of the front tires toe-inward under suspension compression) will result in less off-power steering and running. Too much bump-in can make the steering feel very inconsistent. This effect is obtained by installing a ball stud washer on the bottom of the spindle. Testing has shown that running a little bit of bump-in (kit setup) in the Speed-T offers the best overall setup.

Caster: This is the angle of the kingpin from vertical when viewed from the side of the Speed-T. The Speed-T comes equipped with 30-degree spindle carriers and a 30-degree kick-up angle. Total caster is determined by adding the amount of kick-up (Speed-T has 30 degrees) and the kingpin angle of the front spindle carriers. Increasing total caster will provide more steering entering a turn but less on exit. Decreasing total caster will cause the steering to react faster and increase on-power steering.

Tuning the Rear End of the Speed-T

Shock Location: Moving the shocks out on the arm will result in less forward traction and let the Speed-T make more of an arc through the exit of the turn. In general, when changing shock locations on the arm, it will be necessary to go down one spring rate when moving out on the arm.

Static Camber: Having the same definition as for the front end and measured in the same fashion, rear camber can also be a critical tuning feature. Testing has shown that running a small amount of negative camber (.5-1 degree) is best. Increasing negative rear camber (in the range of 1.5-3 degrees) will increase stability and traction in corners, but decrease high speed stability. Decreasing rear camber (in the range of 0-1.5 degrees) will decrease stability and traction in corners, but will increase high speed stability.

Inboard Camber Location: The Speed-T has multiple rear camber locations. Using a longer camber link will improve stability and traction (grip). Using a shorter camber link will increase steering while decreasing rear grip. Running the camber link in the inside position on the shock tower will give your Speed-T more steering entering the turn as it will let the Speed-T set over the rear tire and give you more forward traction exiting the turn. As you move the camber link towards the outside of the Speed-T, you will gain less initial steering, however, you will gain more steering as the Speed-T exits the turn. The Speed-T now has the capabilities of a lower row of holes in the rear shock tower for the inner camber link location. The lower hole gives the Speed-T more camber gain (more angle relative to arm = more camber gain). This can be helpful when tracks get bumpy and rutted to help the rear end of the Speed-T go through the bumps easier due to the increased camber gain of the tires.

Outboard Camber Location: Running the camber link in the inside position on the hub will generate more rotation entering a turn, but decrease steering on exit. Running the camber link in the furthest outer position on the hub will generate more stability entering a turn and increase steering on exit.

Toe-In: Having the same definition as for the front end, the toe-in can be adjusted on the Speed-T with the rear hubs. The stock toe-in is 3 degrees of inboard per side and 0 degrees in the hub. Increasing rear toe-in will increase forward traction and initial steering, but reduce straightaway speed. Decreasing rear toe-in will decrease forward traction and "free-up" the Speed-T. Less toe-in can be used to gain top speed.

Anti/Pro-Squat: Increasing anti-squat is generated by raising the front of the pivot block, relative to the rear of the pivot. This will increase initial steering and forward traction. You can increase anti-squat in 1 degree increments by using two .030" washers between the front of the pivot plate and pivot block. Pro-squat is generated by raising the rear of the pivot relative to the front. This will decrease forward traction and initial steering, but provide more on-power steering on high traction surfaces. Pro-squat will also help the Speed-T from pulling wheelies on high bite surfaces. Also available is an aftermarket part that is a 0 degree rear pivot block (LOSA2112), if pro-squat is desired it is best to start with this option.

Tuning the Chassis of the Speed-T

Slipper Adjustment: This should be done after the locker-diff is properly adjusted (see page 25). After fully tightening the adjustment nut (so the coils of the spring just touch) loosen the slipper adjustment nut 2 1/4 turns. This will be a good starting point for your slipper settings. Too loose and the vehicle will not have acceleration, and too tight will pop wheelies but can result in a broken locker-diff gear.

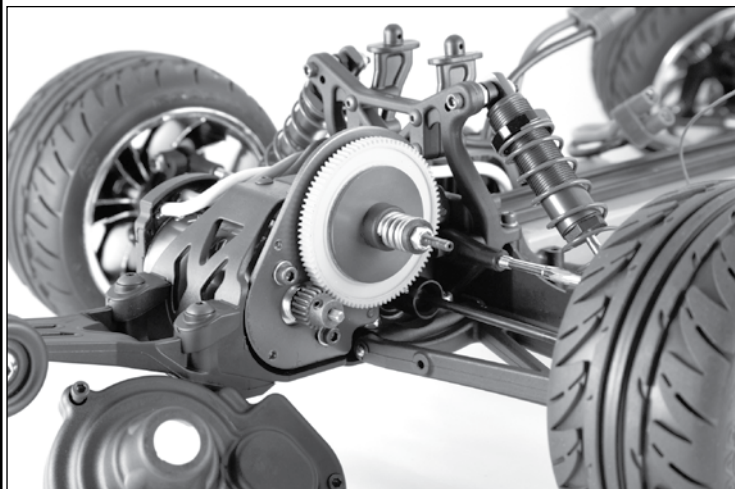

Ride Height: This is the height of the chassis in relation to the surface. It is an adjustment that affects the way your Speed-T jumps, turns and goes through bumps. To check the ride height, drop one end (front or rear) of the Speed-T from about a 5-6 inch height onto a flat surface. Once the Speed-T settles into a position, check the height of that end of the Speed-T in relationship to the surface. To raise the ride height, lower the shock adjuster nuts on the shock evenly on the end (front or rear) of the Speed-T that you are working on. To lower the ride height, raise the shock adjuster nuts. Both left and right nuts should be adjusted evenly.

You should start with the rear ride height where the Speed-T comes to a rest at a height where the dog bones are slightly below level with the surface. The front ride height should be set so that the bottom of the chassis is level with the surface. Occasionally, you may want to raise the front ride height to get a little quicker steering reaction but be careful as this can also make the Speed-T easily flip over. Every driver likes a little different feel so you should try small ride height adjustments to obtain the feel you like. This should be one of the last adjustments after everything else has been dialed in (tuned). Do not use ride height adjustment as a substitute for a change in spring rate. If your Speed-T needs a softer or firmer spring, change the spring. Do not think that simply moving the shock nuts will change the stiffness of the spring; it will not.

Battery Position: This is a critical adjustment that is often overlooked but can be very useful. Start by running the battery spaced in the middle (standard setup with 6-cell battery pack). Moving the battery back can improve rear traction on slippery surfaces and steering response. Moving the battery back too far can cause the rear end to swing through turns on some tracks and “dump” the rear end causing instability issues. This is a result of having the weight too far back. The Speed-T comes equipped with two foam battery spacers to split the difference when adjusting the battery position, hence offering a middle position when either extreme is inadequate.

Camber Rise Relationship: The Speed-T setup out of the box comes with less front camber gain than the rear camber gain. The reason for this is that less front camber lets the front end drive flatter and makes the Speed-T more stable. By having more camber gain in the rear, the Speed-T has more rear traction, this helps the rear tires accelerate through the bumps and ruts.

Wheels and Tires

The tires come pre-mounted with the vehicle and should be checked to make certain they stay glued to the wheels. The wheel spinning speeds this vehicle is capable of tend to pull the rubber tire away from the rim. When a tire or tires come loose from the rim you will notice the vehicle is hard to control.

Tip the vehicle on its side and using both hands to hold one wheel at a time, use your thumb to press the tire away from the rim. If you see a tire pull away for the rim use Losi Tire Glue (LOSA7880 thick or LOSA7881 thin) to re-glug. It only takes a small drop of glue generally. Be careful this is CA-type glue and you do not want to glue your fingers to the wheel and tire.

Use safety goggles when gluing tires.

Check the mounting of the tire periodically to ensure proper performance and handling.

Steering Assembly: Occasionally, check the steering assembly and you may notice increased looseness. There are several components which will wear out from use: tie rod ends (part LOSA6074), the servo saver (part LOSA1610), the bell crank bushings (part LOSA1620), and the Drag link ball ends (LOSA6074). You can easily replace these components to restore factory specifications.

Note: The bell crank bushings may be replaced with ball bearings (part LOSA6912).

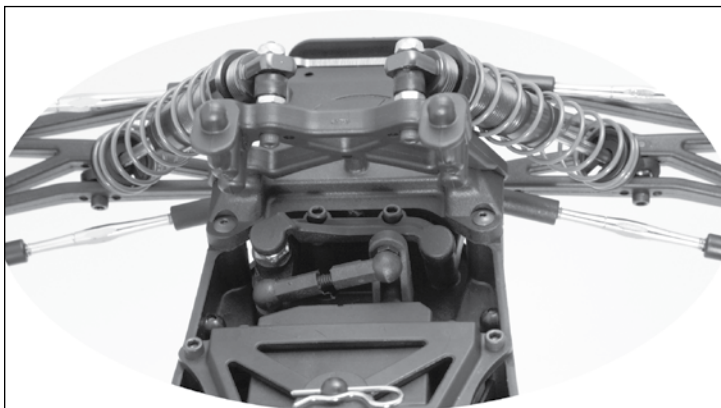

Locker Differential (Spool) (Standard equipment for Speed-T)

The Speed-T makes use of a locker rear differential to equally deliver the power to the rear wheels.

The Locker differential will operate with minimal maintenance.

If you need to take it apart for any maintenance, use the exploded view to reassemble. The differential adjustment screw should be tightened quite tightly using a blade screwdriver (90 to 100 inch pounds). After you reassemble the vehicle hold one wheel and attempt to turn the other, it should take a lot of force to make it turn if any. If the wheels turn you can remove the rear dog bone and expose the adjusting screw. Tighten the screw another 1/8th turn and try again.

Note: If you are running the Speed-T in Off-Road conditions, you may want to use the optional standard ball differential. You can rebuild the Locker differential into the standard differential by removing and disassembling the transmission. Take apart the Locker Differential and remove the two thin pads in the diff gear. You will see there are 12 holes exposed after doing this. Using Losi diff balls (LOSA6951) insert them carefully into these holes. Use a small amount of Losi Diff Grease (LOSA3065) during reassembly. Then after reassembly of the transmission and installation into the vehicle. Please refer to “Standard Ball Differential Adjustment” for further instructions.

Suspension: Periodically inspect the model for signs of damage such as bent or dirty suspension pins, bent turnbuckles, loose screws and any signs of stress or bending. Replace components as needed.

Outdrives: Inspect both outdrive halves for signs of wear. After extended use they will develop a wear mark or notch in them. It requires that you remove the transmission, then disassemble the locker differential. The replacement outdrives are part number LOSA3073.

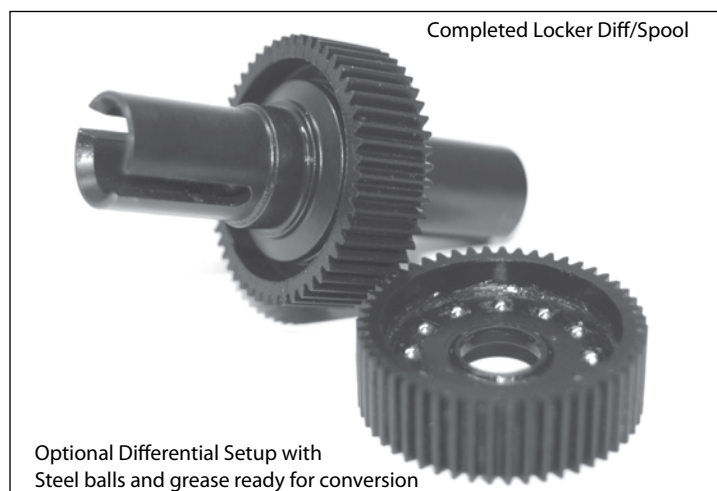

Completed Locker Diff/Spool

Optional Differential Setup with Steel balls and grease ready for conversion



Standard Ball Differential Adjustment: (optional, not included)

Never allow the diff to slip; that's what the slipper is for. Before trying to adjust your diff, you need to tighten the slipper until the spring is fully compressed. Next set the diff setting so it is on the tight side and break the diff in. How you break the diff in is by placing one tire on the tabletop while the other tire is off of the tabletop. Then give the truck about ¼ throttle for 30 seconds. Then do the same thing but place the opposite tire on the tabletop while the other tire is in the air and give the truck ¼ throttle for another 30 seconds. Once that is done you can set the diff. The diff setting will loosen up a little while it is still breaking in and it is important for you to break the diff in prior to driving the truck. Hold the spur gear and right rear tire, then try turning the left rear tire forward. It should be very difficult to turn the left rear tire. If the tire turns easily, the diff is too loose. To tighten the diff, line up the slot in the diff screw with the groove in the left out drive. Place the 1/16" Allen wrench through both of these slots. This will lock the diff screw and the out drive together. While holding the Allen wrench in place, turn the right rear tire forward about 1/8 of a turn. Check the differential adjustment again and repeat the tightening process as necessary until the differential is no longer slipping. Do not forget to reset the slipper setting. See "Slipper Adjustment" on page 24, and then continue from here. The final differential adjustment check should be made by placing the truck on carpet, grass, or asphalt and "punching" (quickly applying) the throttle. The differential should not slip. If it does, tighten the diff in 1/8-turn increments as described above until the slippage stops. Once the diff has been adjusted, it should still operate freely and feel smooth. If the diff screw starts to get tight before the diff is close to being adjusted properly (based on slip), the diff should be disassembled and inspected; you may have a problem with the differential assembly.

Breaking in the Differential:

While holding the chassis with only the left side tires firmly on the ground, give the truck about one quarter throttle, for 10 seconds. The right side tires should spin freely during this time. Repeat this with only the right side tires held firmly to the ground, allowing the left tires to spin. Feel the differential (diff) action and tighten slightly, if necessary. The differential should have a tight, thick feel when rotating it after final adjustment.

CAUTION!

YOUR DIFFERENTIAL SHOULD NEVER BE ALLOWED TO SLIP WHEN RUNNING (A SLIPPING DIFFERENTIAL CREATES A "BARKING" SOUND). IF IT DOES, STOP IMMEDIATELY AND TIGHTEN TO PREVENT DAMAGE.

Adjusting Gear Mesh

Incorrect gear mesh is the most common cause of stripped spur gears. To set the gear mesh, one method is to cut a narrow strip of notebook paper and thread it in between the gears. Loosen the motor screws and slide the motor and pinion gear into the spur gear. Retighten the motor screws and then remove the strip of paper. Or you can loosen the motor and carefully slide the motor leaving a small amount of backlash (play) between the spur and pinion gears. It should not be tight and if you look up-close there should be slight movement of the spur before contacting the teeth on the pinion gear.

Gear Ratio

Changing the gearing provides you a quick and easy way to tune the Speed-T. Use the temperatures of both the Xcelorin motor and your battery pack as a guide to gearing to your environment. When the Motor is above 160-170 degrees Fahrenheit or the batteries are above 125-135 degrees Fahrenheit, these are both strong indications that you should drop the pinion size smaller. This would be a lower gear ratio or larger number for example from 11.25 to 12.40. Going up a pinion size is called gearing higher or a small number for example 11.25 to 10.6 and will increase power consumption and allow more speed.

Use the following formula to calculate the overall ratio for combinations not listed on the gear chart:

$$\frac{\text{Spur Gear Size}}{\text{Pinion Gear Size}} \times 2.43 = \text{Final Drive Ratio}$$

When using higher gear ratios, it is extremely important to monitor the temperatures of the battery and motor. If the battery is extremely hot, and/or the motor is so hot that you cannot touch it, most likely you are over-gearred and drawing a lot of current.

The gear combination that comes on the Speed-T (20-tooth pinion / 88-tooth Spur) provides high-speed running intended for hard surfaces, and this gearing is not recommended for off-road, running in grass or constant starting and stopping.

The following Gearing Tables will provide you a starting point to gear the Speed-T for your desired running surface. Ambient temperature and humidity along with the condition of your equipment play a considerable role in performance.

Use the gear ratio charts and legend to aid in determining the correct pinion and spur for your Speed-T.

Storage

When you are through running the model for the day

- Blow it off with compressed air or use a soft bristled paint brush to dust-off the vehicle.
- Always disconnect and remove the battery from the model whenever the model is stored. If the model will be stored for a long time, then also remove the batteries from the transmitter.



Troubleshooting your Speed-T

Many questions are the result of simple user errors or minor adjustments which are easily addressed. If after reading below you cannot resolve your problem, then please call Horizon Customer Service at 1-888-999-1234.

Radio system does not work properly:

If the power light on the transmitter is not turning on, first ensure the batteries are installed correctly. You should also check that the batteries are good and/or if rechargeable are fully charged. Replace them if needed. If the power light is blinking, then the transmitter batteries are weak and should be replaced. If the transmitter light is on but the radio is still not responding, you may need to re-bind the transmitter to the receiver. Please see page 16

Short radio range:

If the radio range appears short, make sure the batteries are all fully charged and/or are in good condition.

Steering works but the motor will not run:

The speed control may have gotten too hot and thermally shut down (see page 18). Allow time for the speed control to cool. If this is the problem and has happened a few times, consider using a smaller pinion or a larger spur gear.

Check the transmission, do the rear wheels spin easily?

Check that a motor wire has not come loose.

Verify that the electronic speed control is plugged into the throttle channel of the receiver.

Check using another battery. Contact Horizon support for service instructions.

Steering servo does not work:

Check all wires, radio system, battery connectors, and the battery pack.

Contact Horizon support for service instructions.

Motor runs backwards:

Looking directly at the end of the motor the wires attached to the left most should be the Black wire, the center Blue, and the far right should be White. If not please correct. If you are still experiencing problems please contact Horizon support.

Motor starts running immediately after the battery has been connected.

There may be internal ESC damage. Contact Horizon Customer Support.

Off-Road Gearing See Note 1

	84	86	88	90
12	17.01	17.42	17.82	18.23
13	15.70	16.08	16.45	16.82
14	14.58	14.93	15.27	15.62
15	13.61	13.93	14.26	14.58
16	12.76	13.06	13.37	13.67
17	12.01	12.29	12.58	12.86
18	11.34	11.61	11.88	12.15
19	10.74	11.00	11.25	11.51
20	10.21	10.45	10.69	10.94
21	9.72	9.95	10.18	10.41
22	9.28	9.50	9.72	9.94
23	8.87	9.09	9.30	9.51

On-Road Speed Runs

	84	86	88	90
14	14.58	14.93	15.27	15.62
15	13.61	13.93	14.26	14.58
16	12.76	13.06	13.37	13.67
17	12.01	12.29	12.58	12.86
18	11.34	11.61	11.88	12.15
19	10.74	11.00	11.25	11.51
20	10.21	10.45	10.69	10.94
21	9.72	9.95	10.18	10.41
22	9.28	9.50	9.72	9.94
23	8.87	9.09	9.30	9.51
24	8.51	8.71	8.91	9.11

	Safe
	Use Caution
	Not Allowed

Supplied Gear Ratio: **10.69**

Note 1: If using 3S LiPo battery for off-road do not use larger than a 18t pinion gear (Not Included).



Vehicle runs slow/slow acceleration:

Check the battery connectors.

Check to see if the Xcelorin ESC is in a restricted Profile Number 2 or 3 (Default).

Xcelorin ESC has restricted motor speed as a result of thermal protection. Allow time for the ESC to cool down.

Xcelorin has detected Low-Voltage (see page 17).

Vehicle will not reverse:

Make sure the throttle trim is at neutral.

Recalibrate/Setup the ESC (see page 17).

Check to see if the Xcelorin ESC is in profile number 1 that does not have reverse active.

Keep stripping spur gears:

Improper gear mesh, refer to page 26.

Improperly adjusted slipper, refer to page 24.

Warranty Information

Warranty Period

Exclusive Warranty- Horizon Hobby, Inc., (Horizon) warranties that the Products purchased (the "Product") will be free from defects in materials and workmanship at the date of purchase by the Purchaser.

Limited Warranty

(a) This warranty is limited to the original Purchaser ("Purchaser") and is not transferable. REPAIR OR REPLACEMENT AS PROVIDED UNDER THIS WARRANTY IS THE EXCLUSIVE REMEDY OF THE PURCHASER. This warranty covers only those Products purchased from an authorized Horizon dealer. Third party transactions are not covered by this warranty. Proof of purchase is required for warranty claims. Further, Horizon reserves the right to change or modify this warranty without notice and disclaims all other warranties, express or implied.

(b) Limitations- HORIZON MAKES NO WARRANTY OR REPRESENTATION, EXPRESS OR IMPLIED, ABOUT NON-INFRINGEMENT, MERCHANTABILITY OR FITNESS FOR A PARTICULAR PURPOSE OF THE PRODUCT. THE PURCHASER ACKNOWLEDGES THAT THEY ALONE HAVE DETERMINED THAT THE PRODUCT WILL SUITABLY MEET THE REQUIREMENTS OF THE PURCHASER'S INTENDED USE.

(c) Purchaser Remedy- Horizon's sole obligation hereunder shall be that Horizon will, at its option, (i) repair or (ii) replace, any Product determined by Horizon to be defective. In the event of a defect, these are the Purchaser's exclusive remedies. Horizon reserves the right to inspect any and all equipment involved in a warranty claim. Repair or replacement decisions are at the sole discretion of Horizon. This warranty does not cover cosmetic damage or damage due to acts of God, accident, misuse, abuse, negligence, commercial use, or modification of or to any part of the Product. This warranty does not cover damage due to improper installation, operation, maintenance, or attempted repair by anyone other than Horizon. Return of any goods by Purchaser must be approved in writing by Horizon before shipment.

Damage Limits

HORIZON SHALL NOT BE LIABLE FOR SPECIAL, INDIRECT OR CONSEQUENTIAL DAMAGES, LOSS OF PROFITS OR PRODUCTION OR COMMERCIAL LOSS IN ANY WAY CONNECTED WITH THE PRODUCT, WHETHER SUCH CLAIM IS BASED IN CONTRACT, WARRANTY, NEGLIGENCE, OR STRICT LIABILITY. Further, in no event shall the liability of Horizon exceed the individual price of the Product on which liability is asserted. As Horizon has no control over use, setup, final assembly, modification or misuse, no liability shall be assumed nor accepted for any resulting damage or injury. By the act of use, setup or assembly, the user accepts all resulting liability.



If you as the Purchaser or user are not prepared to accept the liability associated with the use of this Product, you are advised to return this Product immediately in new and unused condition to the place of purchase.

Law: These Terms are governed by Illinois law (without regard to conflict of law principals).

Safety Precautions

This is a sophisticated hobby Product and not a toy. It must be operated with caution and common sense and requires some basic mechanical ability. Failure to operate this Product in a safe and responsible manner could result in injury or damage to the Product or other property. This Product is not intended for use by children without direct adult supervision. The Product manual contains instructions for safety, operation and maintenance. It is essential to read and follow all the instructions and warnings in the manual, prior to assembly, setup or use, in order to operate correctly and avoid damage or injury.

Questions, Assistance, and Repairs

Your local hobby store and/or place of purchase cannot provide warranty support or repair. Once assembly, setup or use of the Product has been started, you must contact Horizon directly. This will enable Horizon to better answer your questions and service you in the event that you may need any assistance. For questions or assistance, please direct your email to productsupport@horizonhobby.com, or call 877.504.0233 toll free to speak to a service technician.

Inspection or Repairs

If this Product needs to be inspected or repaired, please call for a Return Merchandise Authorization (RMA). Pack the Product securely using a shipping carton. Please note that original boxes may be included, but are not designed to withstand the rigors of shipping without additional protection. Ship via a carrier that provides tracking and insurance for lost or damaged parcels, as **Horizon is not responsible for merchandise until it arrives and is accepted at our facility.** A Service Repair Request is available at www.horizonhobby.com on the "Support" tab. If you do not have internet access, please include a letter with your complete name, street address, email address and phone number where you can be reached during business days, your RMA number, a list of the included items, method of payment for any non-warranty expenses and a brief summary of the problem. Your original sales receipt must also be included for warranty consideration. Be sure your name, address, and RMA number are clearly written on the outside of the shipping carton.

Warranty Inspection and Repairs

To receive warranty service, you must include your original sales receipt verifying the proof-of-purchase date. Provided warranty conditions have been met, your Product will be repaired or replaced free of charge. Repair or replacement decisions are at the sole discretion of Horizon Hobby.

Non-Warranty Repairs

Should your repair not be covered by warranty the repair will be completed and payment will be required without notification or estimate of the expense unless the expense exceeds 50% of the retail purchase cost. By submitting the item for repair you are agreeing to payment of the repair without notification. Repair estimates are available upon request. You must include this request with your repair. Non-warranty repair estimates will be billed a minimum of 1/2 hour of labor. In addition you will be billed for return freight. Please advise us of your preferred method of payment. Horizon accepts money orders and cashiers checks, as well as Visa, MasterCard, American Express, and Discover cards. If you choose to pay by credit card, please include your credit card number and expiration date. Any repair left unpaid or unclaimed after 90 days will be considered abandoned and will be disposed of accordingly. **Please note: non-warranty repair is only available on electronics and model engines.**

Electronics requiring inspection or repair should be shipped to the following address:

Horizon Service Center
4105 Fieldstone Road
Champaign, Illinois 61822

All other Products requiring warranty inspection or repair should be shipped to the following address:

Horizon Product Support
4105 Fieldstone Road
Champaign, Illinois 61822

Please call 877-504-0233 with any questions or concerns regarding this product or warranty.

Instructions for Disposal of WEEE by Users in the European Union

This product must not be disposed of with other waste. Instead, it is the user's responsibility to dispose of their waste equipment by handing it over to a designated collection point for the recycling of waste electrical and electronic equipment. The separate collection and recycling of your waste equipment at the time of disposal will help to conserve natural resources and ensure that it is recycled in a manner that protects human health and the environment. For more information about where you can drop off your waste equipment for recycling, please contact your local city office, your household waste disposal service or where you purchased the product.



RC Terminology

BEC (Battery Elimination Circuit) – The BEC is used to eliminate the need for a receiver pack to power the radio system. On most electric vehicles this is located in the electronic speed control (ESC), but can also be a stand-alone device.

BIND Process – Programming a receiver to recognize the GUID code of only one specific transmitter or transmitter module.

Brushless Motor – A brushless motor differs from the traditional brushed motor in several ways. As the name indicates there are no brushes used to transfer current to the windings. The brushless motor windings are located in the can, where in a brushed motor they are on the armature. The armature in a brushless motor is replaced by a rotor, which is magnetic and spins within the windings on the can. An ESC is required to run and control a brushless motor where a traditional brushed motor can be run by connecting power to the positive and negative tabs.

Calibration – Also called ESC setup. It is the process used to match the transmitter throttle, brake and neutral to the ESC.

Capacitor – An electronic component used to store voltage. The Xcelorin ESC uses a capacitor to store energy from the braking action of the ESC.

Cogging – This term describes a brushless motor when starting from a complete stop. The ESC and motor work together during the start from a complete stop, and it is during this startup process you may notice some stuttering of the vehicle until it is rolling in either direction.

Current – Refers to the power flow from the battery to the ESC and Motor when used in the RC vehicle environment. Typically this is measured in Ampere or Amp.

Deadband – This refers to the amount of travel (movement) on the transmitter trigger before the vehicle is requesting the ESC to move the vehicle forward or backwards. It is an advanced adjustment used by experienced drivers.

Drag Brake – Refers to the amount of brake applied when driving the vehicle that is applied when you return the transmitter trigger to the neutral position. This advanced adjustment is used by experienced drivers and is adjusted on the ESC to the feel of the driver.

DSM – (Digital Spectrum Modulation) – The 2.4GHz technology that makes Spektrum possible.

ESC (Electronic Speed Control) – The ESC is what translates the signals past from the transmitter trigger through the receiver into commands that reach the motor to signal forward or reverse, acceleration or braking. The Xcelorin system is an advanced electronic speed controller that is very efficient in passing precise requests to the brushless motor. The BEC is also controlled by the ESC along with the Low Voltage Protection circuit.

GUID – Globally Unique Identification Code. Each individual module or radio is factory programmed with its own unique serial code. In the binding process, the receiver is programmed to only recognize the GUID code of one specific radio or module.

Kv Rating – This is the rating used for most brushless motors rather than turns, which is the rating for brushed motors. A Kv number for a motor is stating the Revolutions Per Minute (RPM) that will be developed if one volt is supplied without a load. The motor supplied with the Speed-T is a 4800Kv motor, which would develop 4800 RPM at the one volt measurement.

LiPo – A Lithium Polymer battery's abbreviation indicating the chemistry used in these rechargeable batteries. These batteries require special attention by the user and are only recommended for the most experienced of users.

Low Voltage Cutoff (LVC) – This is a setting for the ESC, to help protect the investment into expensive LiPo batteries. When the ESC turns on a Red LED light on the Xcelorin ESC this indicates LVC has been reached, and at the same time power to the motor will be reduced as another indication for the driver that the battery is close to full discharge. For NiCd or NiMH batteries only this setting can be set to "no cutoff."

mAh – The Milliampere Hour abbreviation, which represents the capacity of a battery pack. The higher this rating the longer the run time of each charge.

Neutral Position – Referring to the Transmitter when at rest, meaning the throttle trigger and steering have no input. When you turn the transmitter on set it to the side while turning the car on, the transmitter will be in a Neutral state.

NiMH – The abbreviation for nickel-metal hydride rechargeable batteries. These have replaced the use of NiCd batteries as the battery of choice in RC vehicles.

Profiles – The Xcelorin ESC has three (3) preset profiles. Each profile contains the individual ESC settings that are collectively called a profile. There is a beginner profile, an expert profile, and a beginner LiPo profile that can easily be retrieved and used simplifying ESC use for the user. These profiles do not limit the ability to make further settings changes to the ESC but are a good reference and starting point.

Receiver – A device mounted into the vehicle that receives and decodes a signal sent by a transmitter. Servos, ESC and other devices are plugged into the receiver.

Resistance – As used here is referring to the power loss from the battery to the ESC and Motor. Typically this is measured in Ampere or Amp. Too much resistance between the battery, ESC and motor can result in low performance and run time.

Rotor – This is the brushless motors equivalent to an armature in a brushed motor. The rotor is the shaft protruding from the end of the motor for mounting of the pinion gear to drive the vehicle. The rotor has a magnet secured to it inside of the motor.

Sensorless – Is a type of brushless system, of which there are two primary types: Sensorless and Sensored. The Sensorless system uses the ESC to determine the rotation of the rotor in the motor, no feedback is provided by the motor itself. In the Sensored system, the ESC and Motor are connected via a sensor cable in addition to the three wires found on a Sensorless system. This cable allows the motor to communicate directly to the ESC providing further controls.

Servo – An electronic device connected to the receiver used to actuate steering control of the vehicle.

Solder Tabs – The Xcelorin 4800Kv motor in the Speed-T has three solder tabs to attach the motor leads from the ESC.

Spektrum – The technology brand of 2.4GHz radio system supplied with the Speed-T. The use of this technology eliminates the concern of conflicting frequencies found with older legacy radio systems. It further reduces to a minimum potential radio interference common with the legacy radio systems of the past.

Spool – Is a variation of the differential and provides positive drive under acceleration. The components are the same as a normal differential without using the steel balls, which are replaced by Spool Pads. The spool can be easily converted into a differential by removal of the Spool Pads and inserting the steel balls.

Transmitter – Is the device held in your hand that relays steering and throttle/brake requests made to the receiver.

Trim – This is a setting used on the transmitter to make fine adjustments to the steering or throttle/brake trigger. For steering you would use the trim to make the adjustment for the vehicle to drive straight without adding steering input to the transmitter.

Thermal Shutdown – Refers to the ESC operating temperature. The Xcelorin ESC monitors its internal temperature and will automatically prevent the ESC from delivering power to the motor, preventing damage due to over heating the ESC's electronics.



Replacement Parts List

Part Number	Description	Price
LOSA1022	Front Axles for XX-T Wheels (GTX, NXT, XXX-T)	\$6.00
LOSA1113	Front Shock Tower (Speed-T)	\$5.99
LOSA1118	Front Suspension Arms (Speed-T)	\$7.99
LOSA1146	Front Outer & Kingpins 3/32" (XX, 'CR', XXX, XXX-T)	\$3.00
LOSA1150	Front Outer Hinge Pin (XXX-T)	\$3.50
LOSA1610	Steering Hardware Set	\$3.50
LOSA1615	Short Ball Cups and Threaded Rod	\$2.75
LOSA1620	Steering/Servo Mount Assembly (XXX, XXX-T)	\$6.00
LOSA17684B	320S Road Weapons w/Spokez Mntd Front-Blue (2)	\$27.99
LOSA17684V	320S Road Weapons w/Spokez Mntd Front Violet (2)	\$27.99
LOSA2006	Swivel Suspension Balls .250" (8)	\$4.00
LOSA2007	Hinge Pin 1.42" (XXT, XXX, XXX-T)	\$3.00
LOSA2105	Rear Shock Tower (Speed-T)	\$5.99
LOSA2108	Rear Pivot Plate (XXX, XXX-T)	\$4.00
LOSA2143	Rear Suspension Arms (Speed-T)	\$8.50
LOSA2164	1/8" Upper Bulkhead / Outer Rear Hinge Pin (2)	\$3.00
LOSA2166	Inner Rear Hinge Pins (XXX, XXX-T)	\$3.00
LOSA27684B	320S Road Weapons w/Spokez Mntd Rear-Blue (2)	\$27.99
LOSA2910	Diff Screw, Hardware, Seal Set (Sport)	\$4.50
LOSA2911	One-Piece Diff Nut/Carrier	\$3.50
LOSA2942	Motor Plate and Front Pin Brace (Speed-T)	\$8.99
LOSA2945	Locker Differential Gear: Speed-T	\$9.99
LOSA2960	RCVD Set Axle, Dog Bone Hdw	\$19.99
LOSA3033	Transmission Case Set and Spacers (XXX, XXX-T)	\$6.00
LOSA3034	Transmission Screw Set (XXX, XXX-T)	\$2.50
LOSA3042	Gear Cover with Access Plug (Speed-T, XXX-T CR)	\$5.00
LOSA3060	Slipper Shaft, Spacer & Hardware	\$5.50
LOSA3066	Teflon™ Assembly Lube	\$2.50
LOSA3070	Transmission Drive Rings (2)	\$2.00
LOSA3072	Differential Tube	\$2.25
LOSA3073	Outdrive Cup/Diff Half	\$7.00
LOSA3075	Transmission Upper Gear, Idler, Shaft	\$6.00
LOSA3079	Idler Gear (2.19:1 and 2.43:1)	\$3.50
LOSA3099	Full Compliment Thrust Bearing Set	\$5.00
LOSA3123	Slipper Pad	\$3.00
LOSA3124	Slipper Spring, Cup, Spacer, Bushing, and Washer	\$3.00
LOSA3132	Slipper Backing Plate	\$6.00
LOSA3928	88T 48-Pitch Spur Gear	\$3.50
LOSA4004	Servo Tape (6)	\$1.75
LOSA4015	Foam Battery Block.....	\$7.99
LOSA4120	48 Pitch Pinion Gear, 20T	\$5.99
LOSA4109	Main Chassis and Brace (XXX-TCR-Speed T)	\$24.99
LOSA4122	Front Kickplate, Bulkhead, and Steering Brace(XXX,T)	\$9.00
LOSA4125	Front Spindles/Carriers, and Rear Hubs (XXX-T)	\$7.50
LOSA4126	Front and Rear Pivot Block Set (XXX, XXX-T)	\$6.00
LOSA4132	Front Bumper, Motor Guard (Speed T)	\$6.99
LOSA4133	Front & Rear Body Mounts Set: Speed-T	\$4.99
LOSA4134	Wheelie Bar Set: Speed-T	\$9.99



Part Number	Description	Price
LOSA4136	Front and Rear Inner Pin Brace Set (XXX, XXX-T)	\$3.00
LOSA4170	Battery Strap, Pad, and Foam Block (XXX-TCR-Speed-T)	\$4.49
LOSA4224	Threaded Chassis Inserts - Short and Long	\$6.50
LOSA5013	Front and Rear Upper Shock Mount Bushings (XXX,T)	\$3.00
LOSA5015	Double O-Ring Shock Cartridge	\$2.00
LOSA5017	1.0" Shock Shaft	\$3.00
LOSA5023	Spring Clamps & Cups (2)	\$2.50
LOSA5045	Shock Pistons #56 (Red) (4)	\$3.00
LOSA5047	Shock Pistons #55 (Orange) (4)	\$3.00
LOSA5051	Shock Adjuster Nuts (4): Speed-T	\$7.99
LOSA5073	Shock Bodies, Blue (Pr): Speed-T	\$14.99
LOSA5158	2.5" Spring 2.7 Rate Front (Green)	\$2.50
LOSA5160	2.5" Spring 4.1 Rate Rear (Blue)	\$2.50
LOSA5226	Team Losi Certified Shock Fluid 40 wt Front	\$3.50
LOSA5228	Team Losi Certified Shock Fluid 60 wt Rear	\$3.50
LOSA6001	Ball Studs w/Rod Ends 4-40 x 3/16" (4)	\$3.50
LOSA6020	H.D. 30-degree Plastic Rod Ends (Sport)(12)	\$4.50
LOSA6030	Assembly Wrench (version 2)	\$1.50
LOSA6044	HD Rod Ends & Balls	\$5.00
LOSA6074	Adjustable L/R Turnbuckle Set (6) (Speed T)	\$9.99
LOSA6100	1/8" E-Clips	\$1.25
LOSA6102	C-clips, 1875" - Large (12)	\$1.75
LOSA6201	3mm x 8mm Cap-Head w/Washers (10)	\$3.00
LOSA6204	4-40 x 1/2" Cap-Head Screws (10)	\$1.50
LOSA6206	4-40 x 3/8" Cap-Head screws (10)	\$1.50
LOSA6210	4-40 x 3/8" Flat-Head Screws (10)	\$1.50
LOSA6215	#4 Narrow Washers (10)	\$1.25
LOSA6216	4-40 x 7/8" Cap-Head Screws (10)	\$1.50
LOSA6221	4-40 x 5/8" Cap-Head Screws (10)	\$1.50
LOSA6229	4-40 x 3/8" Button-Head Screws (10)	\$2.00
LOSA6230	Shim Assortment - 3/16", 1/4", 1/2" (20)	\$2.50
LOSA6233	4-40 x 5/8" Flat-Head Screws (10)	\$2.50
LOSA6300	4-40 Hex Nuts (10)	\$1.00
LOSA6303	10-32 Locknuts (4ea Nylon & Steel) (8)	\$1.50
LOSA6305	4-40 Aluminum Locknuts, Low Profile (10)	\$3.50
LOSA6306	4-40 Aluminum Mini Nuts (10)	\$3.50
LOSA6350	#4 and 1/8" Hardened Washers	\$2.50
LOSA6401	1/16" Pins for Wheels and Gears	\$1.25
LOSA6903	3/16" x 3/8" Teflon™-Sealed Bearings (2)	\$5.50
LOSA6907	5mm x 8mm Bearings	\$6.50
LOSA6908	1/2" x 3/4" Ball Bearings w/Teflon Seal (2)	\$14.25
LOSA6909	1/8" x 3/8" Ball Bearings ('XX' Trans) (2)	\$6.00
LOSA7058	320 Series Spokez Chrome Wheel, Front (2)	\$10.99
LOSA7158	320 Series Spokez Chrome Wheel, Rear (2)	\$10.99
LOSA7684B	320 Series Road Weapon Tires, Fr/R Blue (2)	\$17.99
LOSA7684V	320 Series Road Weapon Tires, Fr/R Violet (2)	\$17.99
LOSA8200	Body Clips (12)	\$1.25
LOSA9941	Bearing Spacer/Wheel Washer	\$9.95



Optional Parts for the Speed-T

Part Number	Description	Price
LOSA2961	CVD Rebuild Kit: Speed-T	\$5.99
LOSA3009	Differential Balls 3/32" (12) (Optional)	\$1.25
LOSA3065	Silicone Differential Compound (Optional)	\$2.50
LOSA3927	90-Tooth, 48-Pitch Spur Gear for Double-Disk Slipper	\$3.50
LOSA3929	86-Tooth, 48-Pitch Spur Gear for Double-Disk Slipper	\$3.50
LOSA3930	84-Tooth, 48-Pitch Spur Gear for Double-Disk Slipper	\$3.50
LOSA3932	78-Tooth, 48-Pitch Spur Gear for Double-Disk Slipper	\$3.50
LOSA3933	76-Tooth, 48-Pitch Spur Gear for Double-Disk Slipper	\$3.50
LOSA4112	48 Pitch Pinion Gear, 12T	\$4.00
LOSA4113	48 Pitch Pinion Gear, 13T	\$4.00
LOSA4114	48 Pitch Pinion Gear, 14T	\$4.00
LOSA4115	48 Pitch Pinion Gear, 15T	\$4.00
LOSA4116	48 Pitch Pinion Gear, 16T	\$4.00
LOSA4117	48 Pitch Pinion Gear, 17T	\$4.00
LOSA4118	48 Pitch Pinion Gear, 18T	\$4.00
LOSA4119	48 Pitch Pinion Gear, 19T	\$4.00
LOSA4121	48 Pitch Pinion Gear, 21T	\$4.00
LOSA5064	1.0" Titanium Nitride Shock Shaft	\$7.00
LOSA6912	3/32" x 3/16" Bearings for Steering (XX, XXT, XXX, T)	\$19.95
LOSA6951	3/32" Carbide Diff Balls (12)	\$10.95
LOSA9713	Graphite Kickplate, Bulkhead, & Steering Brace	\$16.00
LOSA9831	Graphite/Composite Rear Pivot Plate (XXX, XXX-T)	\$6.50
LOSA9940	Aluminum Hardcoated Suspension Balls	\$3.95
LOSB8045	Speed-T Painted Body, Silver w/stickers	\$35.99
LOSB8046	Speed-T Painted Body, Blue w/stickers	\$35.99
LOSB8047	Speed-T Painted Body, Burgundy w/stickers	\$35.99
LOSB8048	Speed-T Painted Body, Black w/stickers	\$35.99
LOSB8049	Speed-T Body, Clear w/stickers	\$25.99
LOSB9610	TAM to EC3 Charge Adaptor.....	\$7.99
LOSB9613	EC3 Charge Lead, 12" w/Banana Plug.....	\$4.99
LOSB9860	11.1V 3200mAH 3-Cell LiPo	\$154.99
LOSB9861	7.4V 5000mAH 2-Cell LiPo.....	\$129.99
LOSB9901	4600 NiMH 6-Cell High Performance Side-by-Side EC3	\$89.99
LOSB9902	4600 NiMH 7-Cell High Performance Side-by-Side EC3	\$104.99

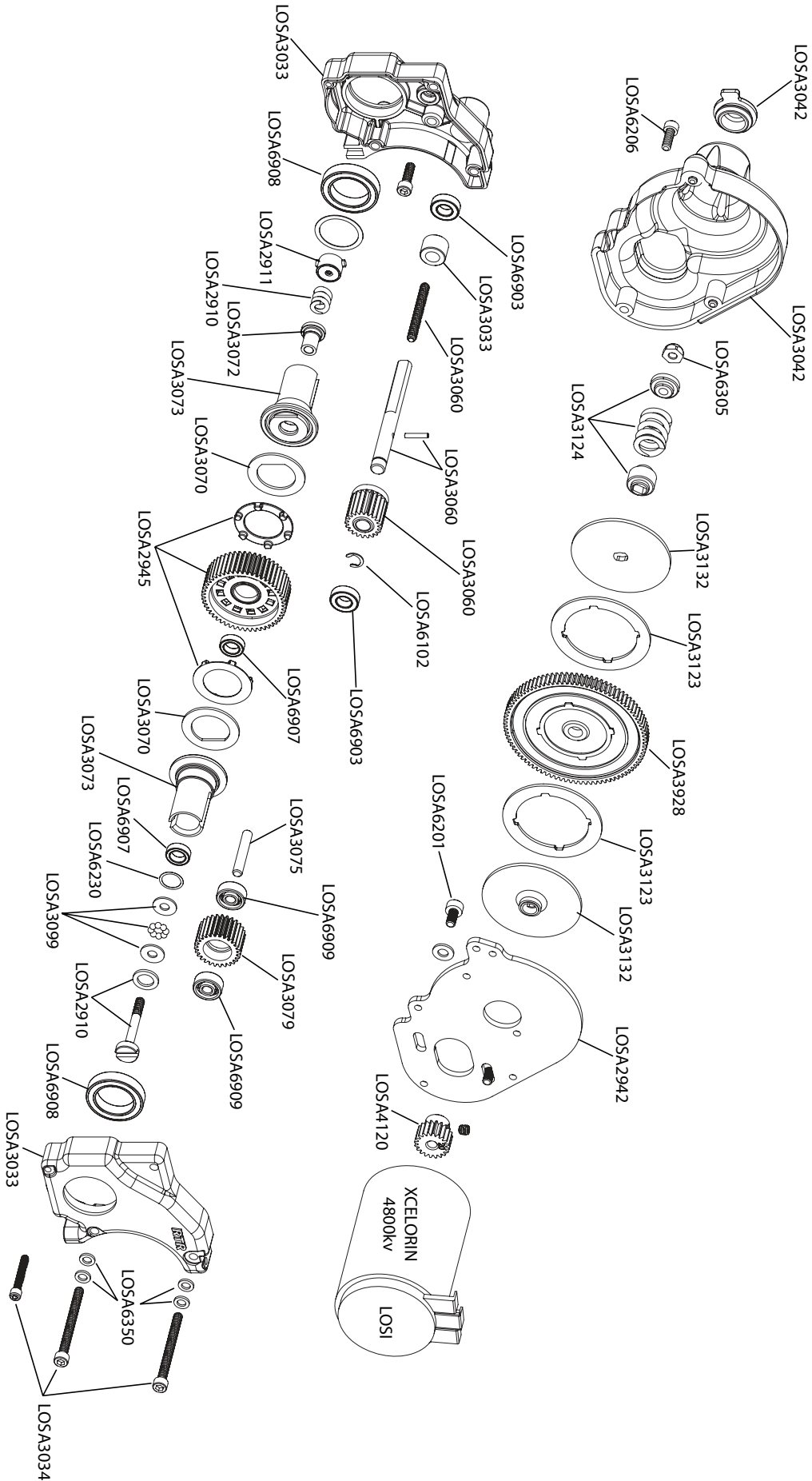

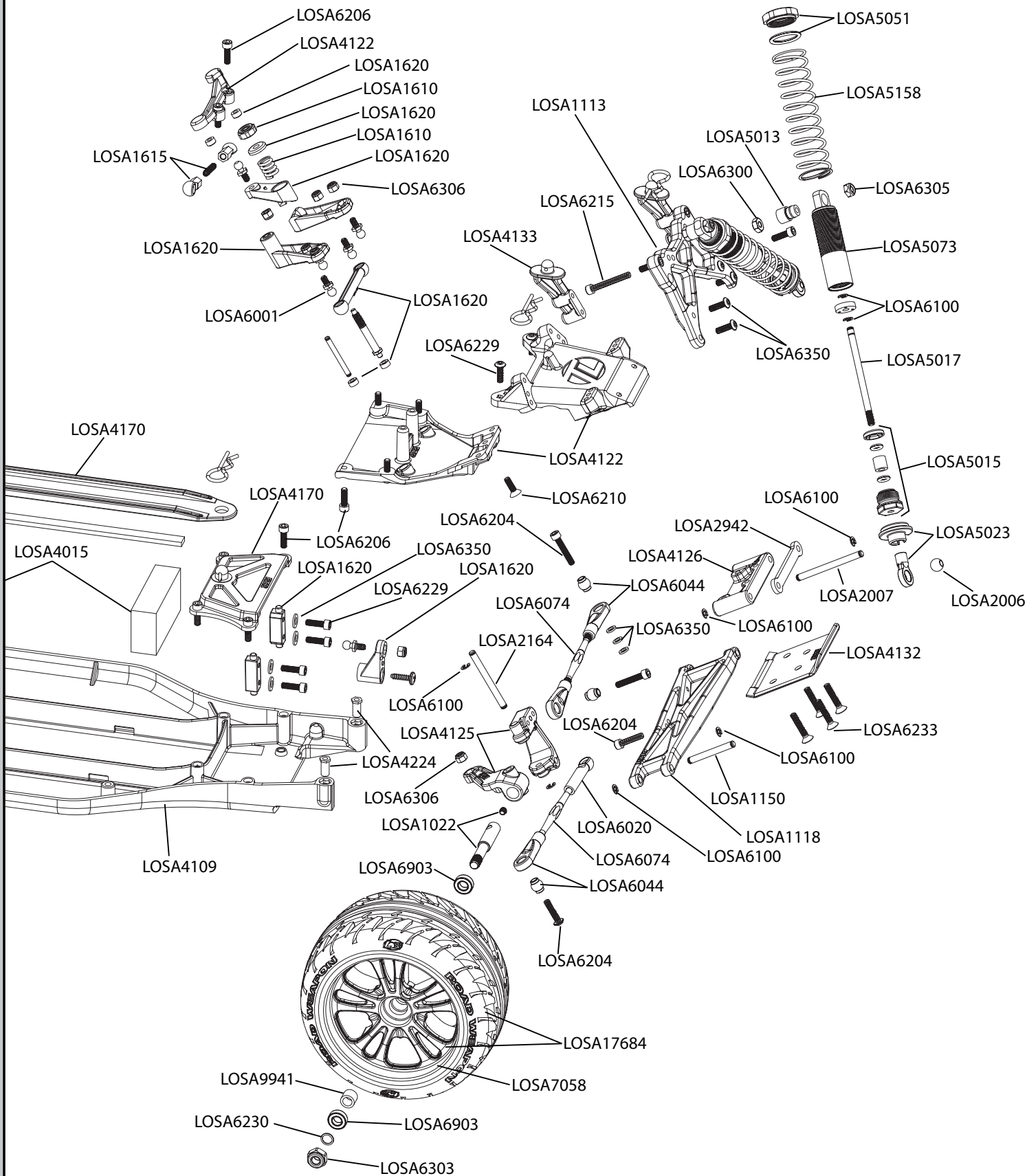



SPEED-T



©2008 Losi, A division of Horizon Hobby, Inc.
Not responsible for typographical errors.
All pricing subject to change without notice.

800-0349
12660.1